

- LEYENDA
- DELIMITACION DEL SECTOR
 - TUBERIA PE Ø 200
 - TUBERIA PE Ø 110
 - TUBERIA PE Ø 90
 - TAPON

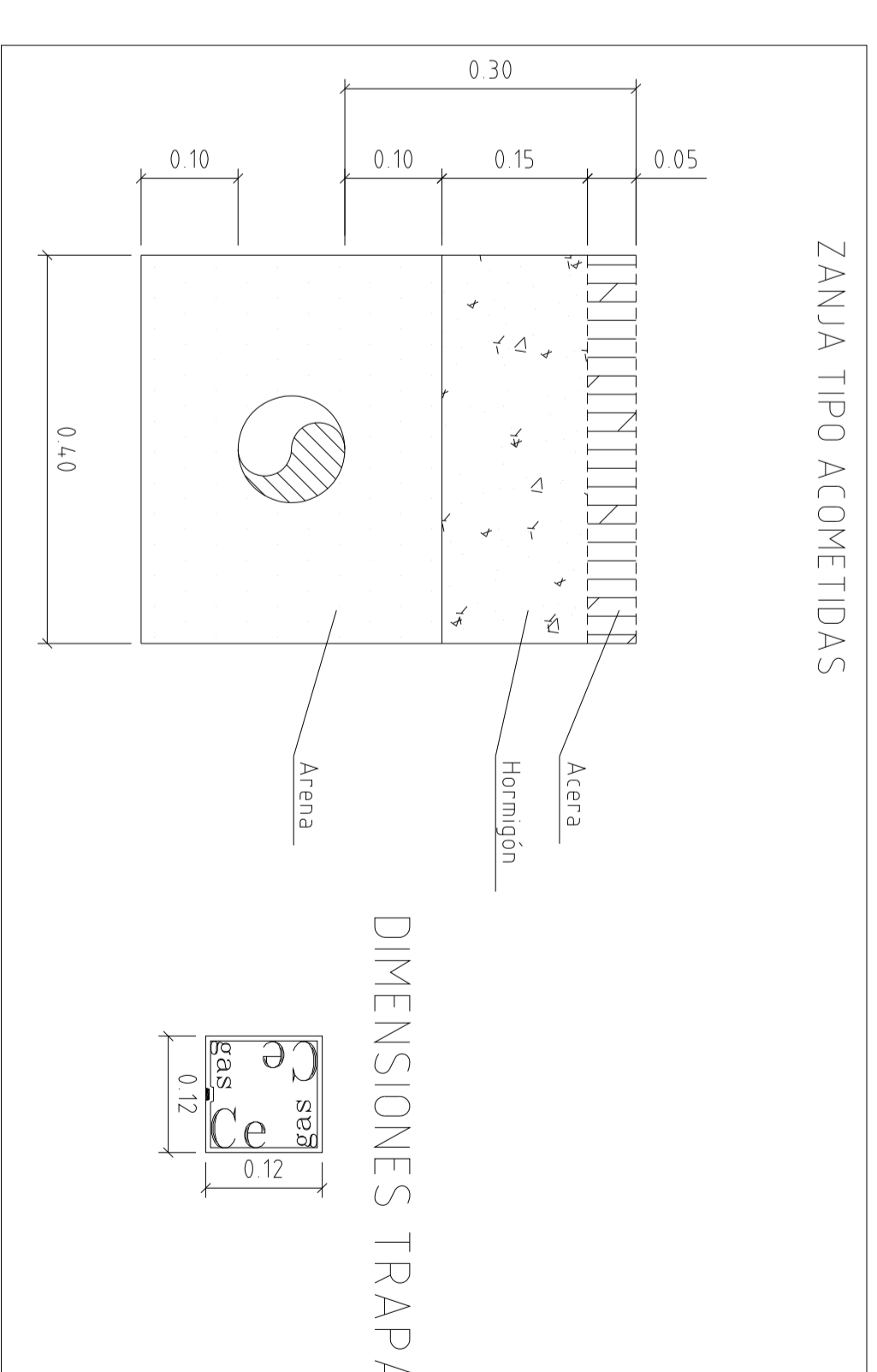
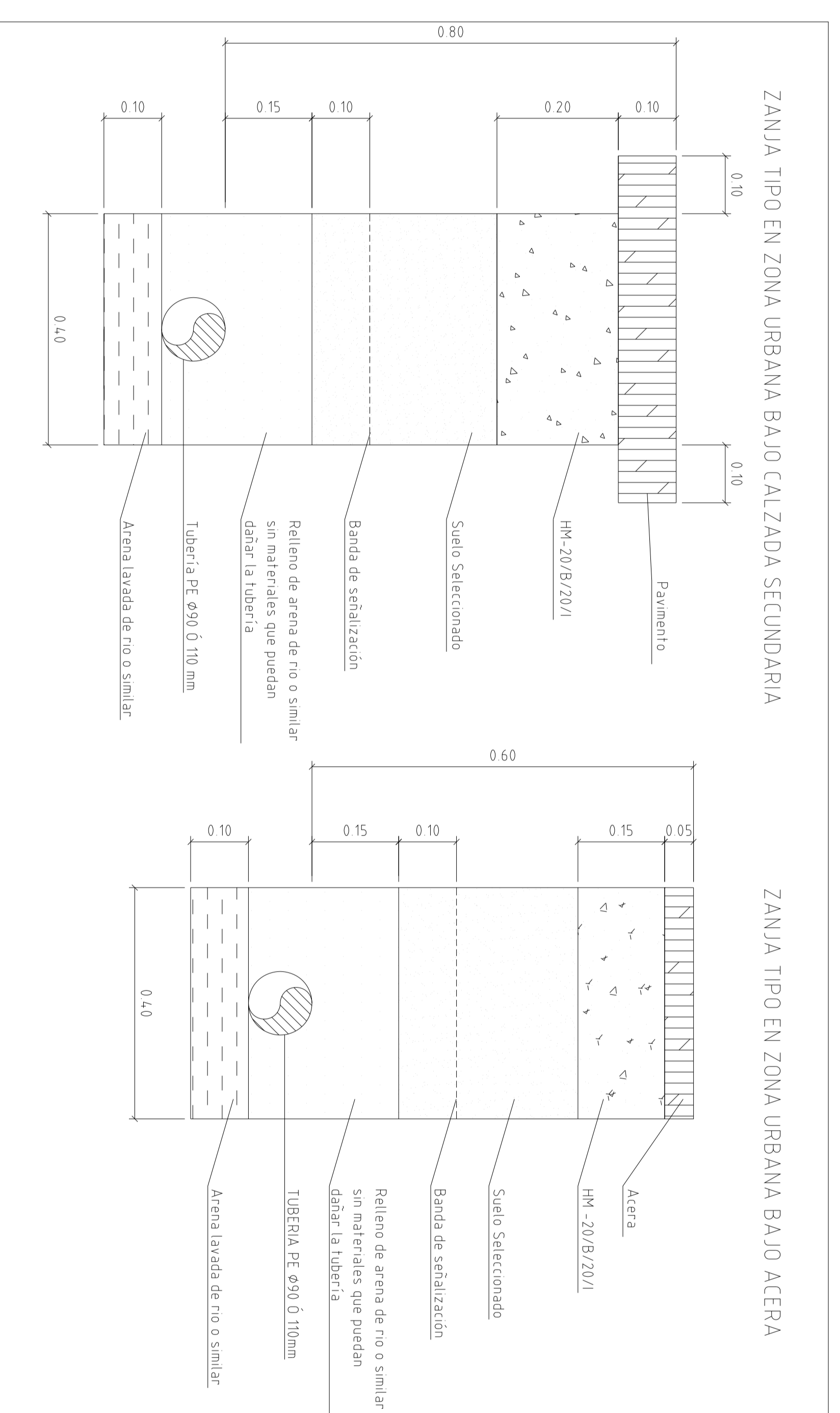
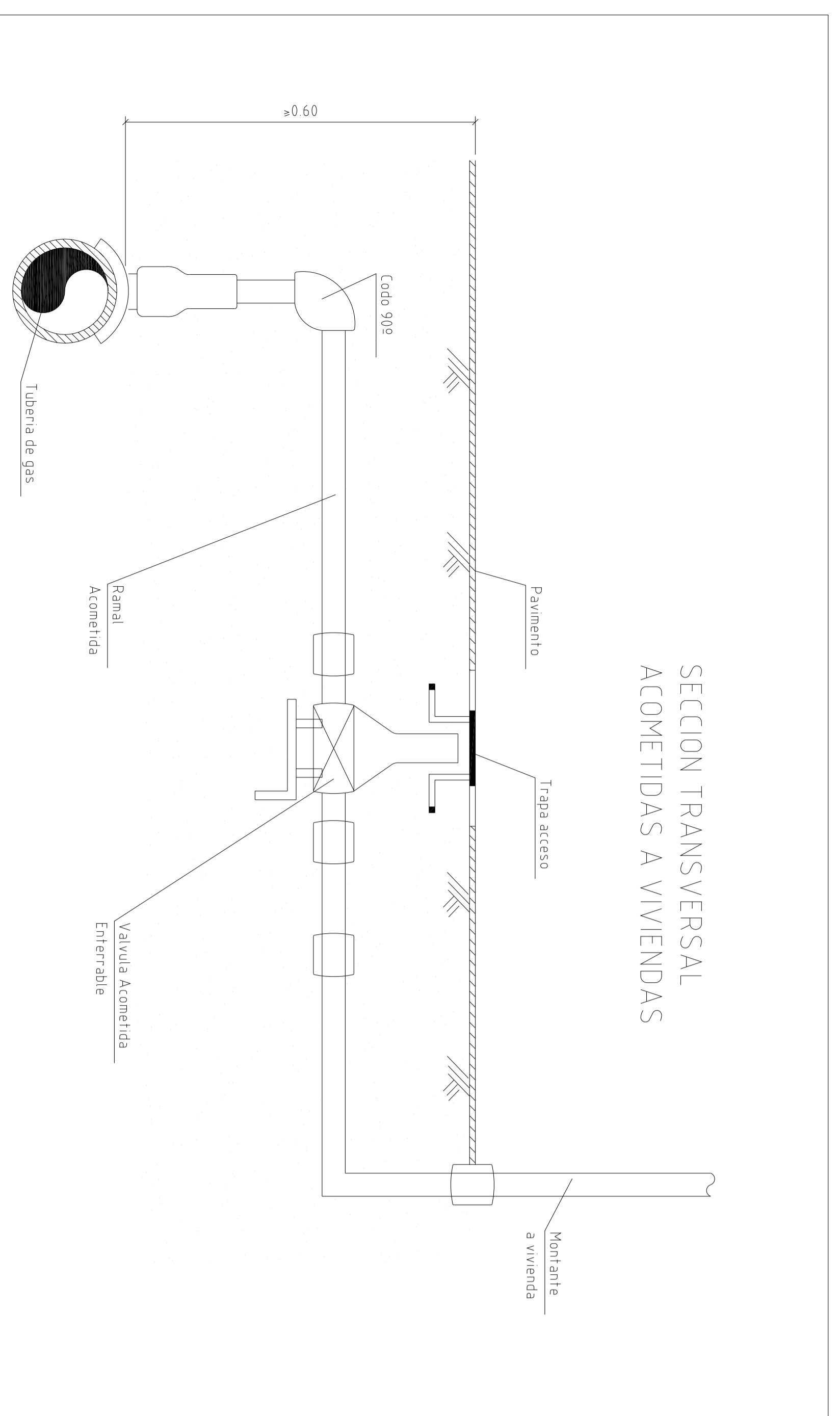
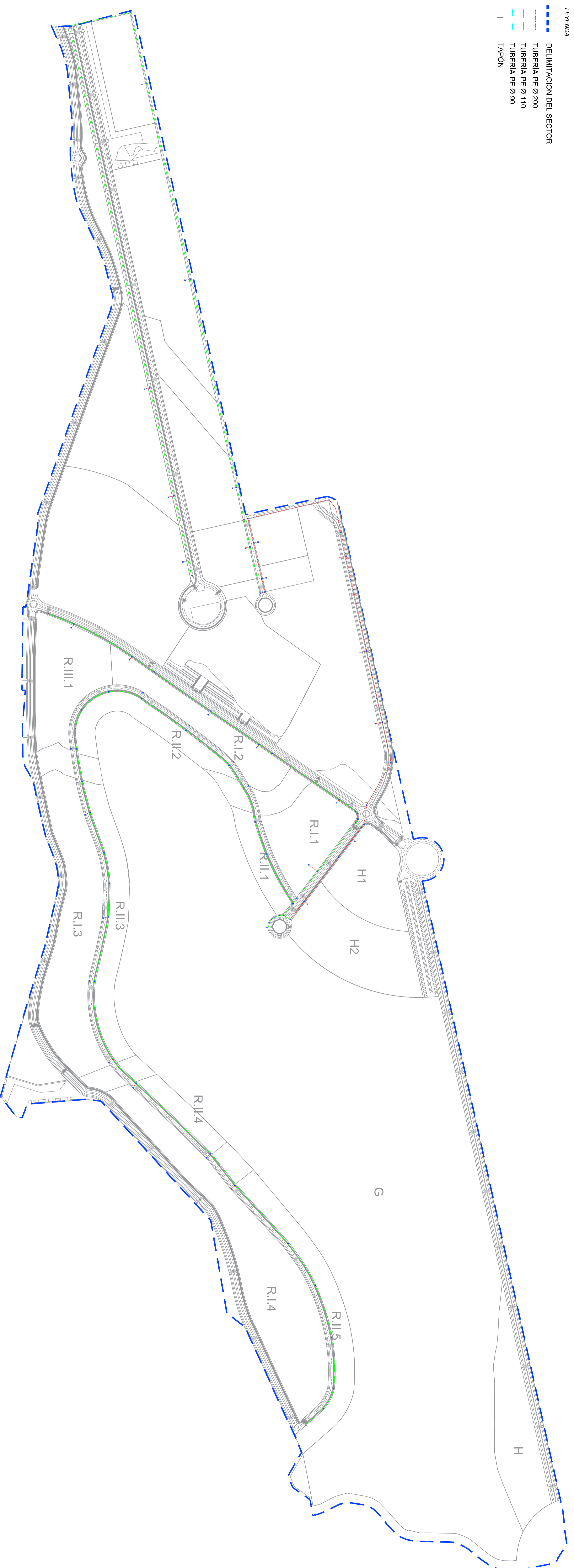

PROYECTO DE URBANIZACIÓN DEL SECTOR "PEGO GOLF" EN PEGO (ALICANTE).

REPRESENTA RED DE GAS

ESCALA 1/3000 ORIGINAL A0

FECHA FEBRERO 2023

Nº PLANO P 10

PROPIEDAD CONSTRUCCIONES HISPANO GERMANAS S.A.

DELIMITACION DEL SECTOR

| LEYENDA | |
|---------|------------------|
| | 6xØ63 |
| | 4xØ63 |
| | 2xØ63 |
| | 4xØ40 |
| | 2xØ40 |
| | Arqueta TIPO D |
| | Arqueta TIPO H |
| | Arqueta TIPO M |
| | A.D.A. |
| | A.I. 6 Armario J |
| | Acometida |

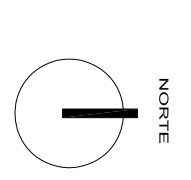
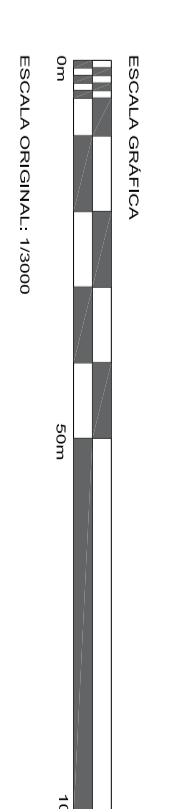
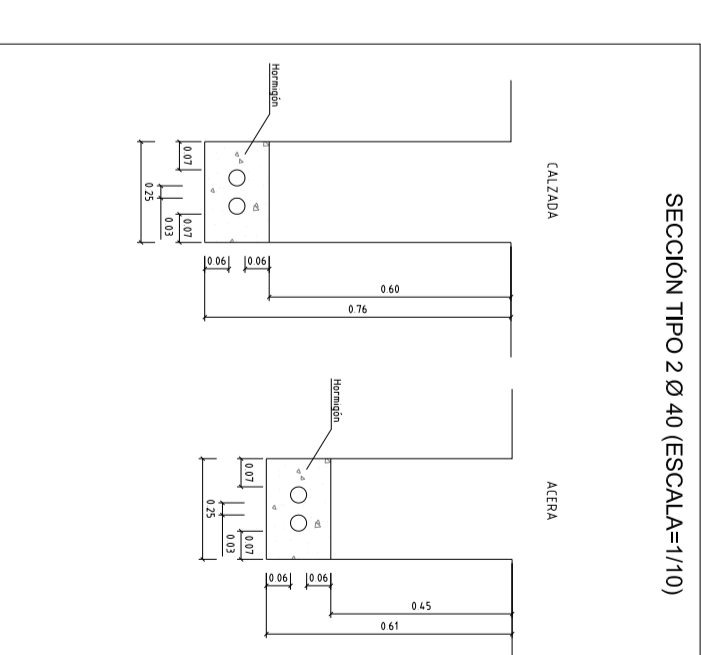
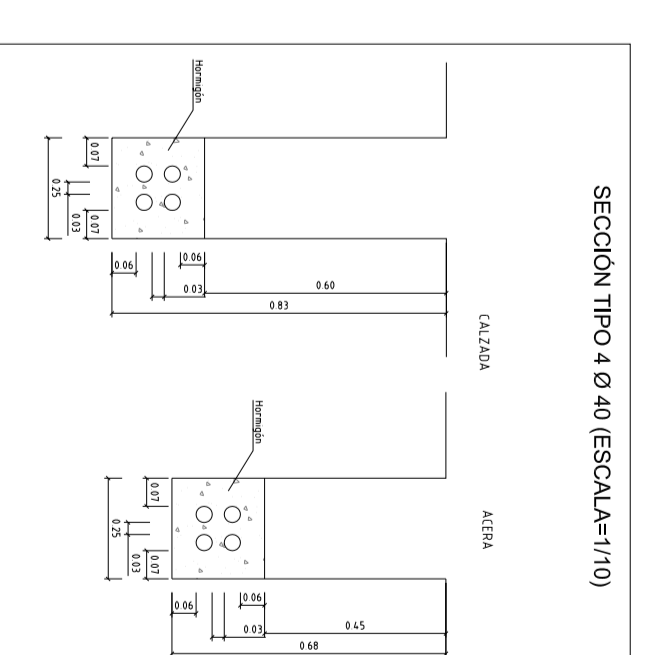
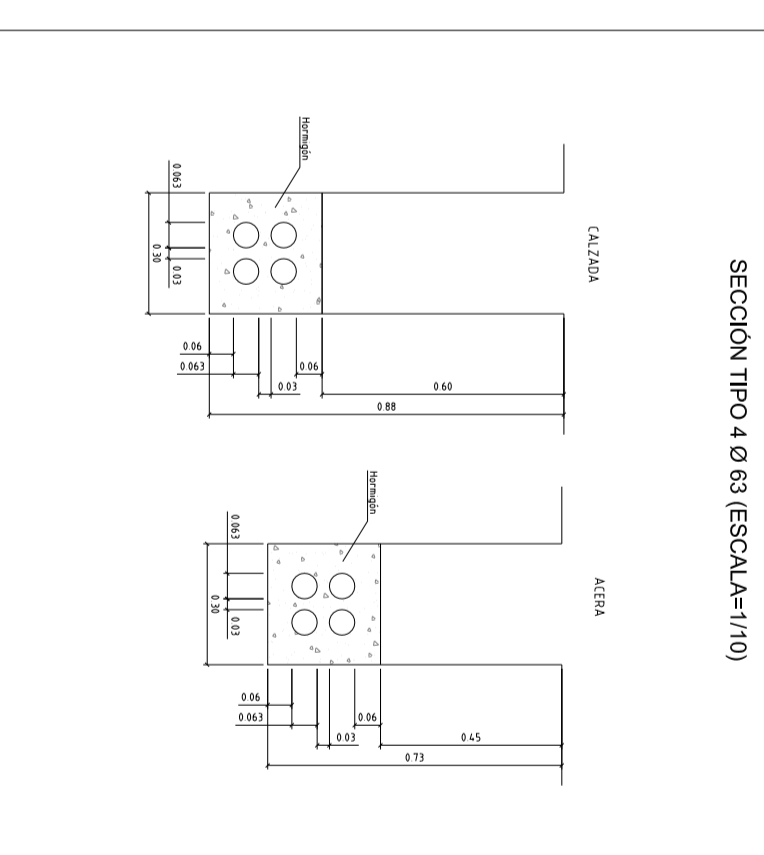
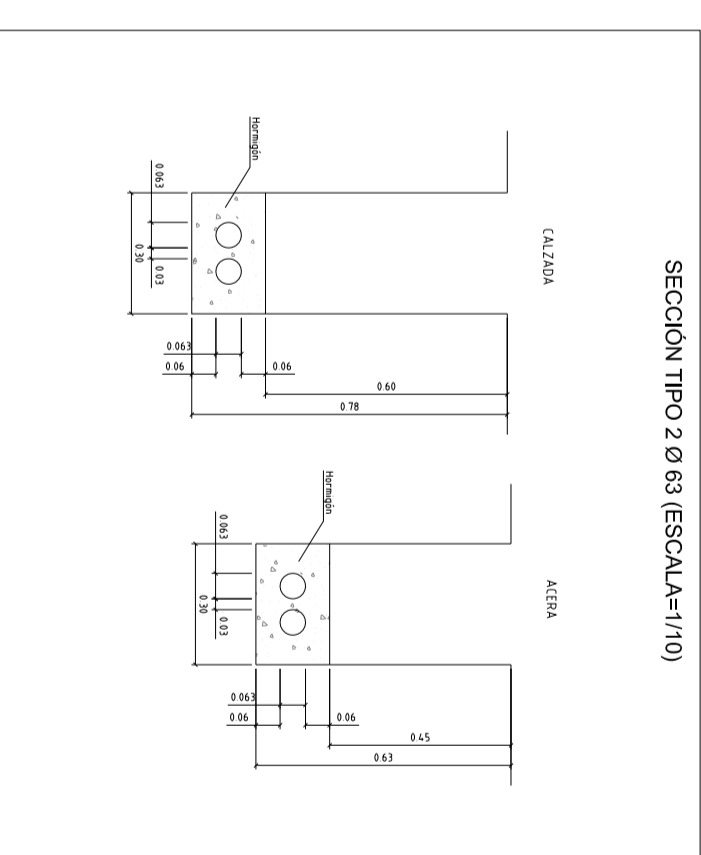
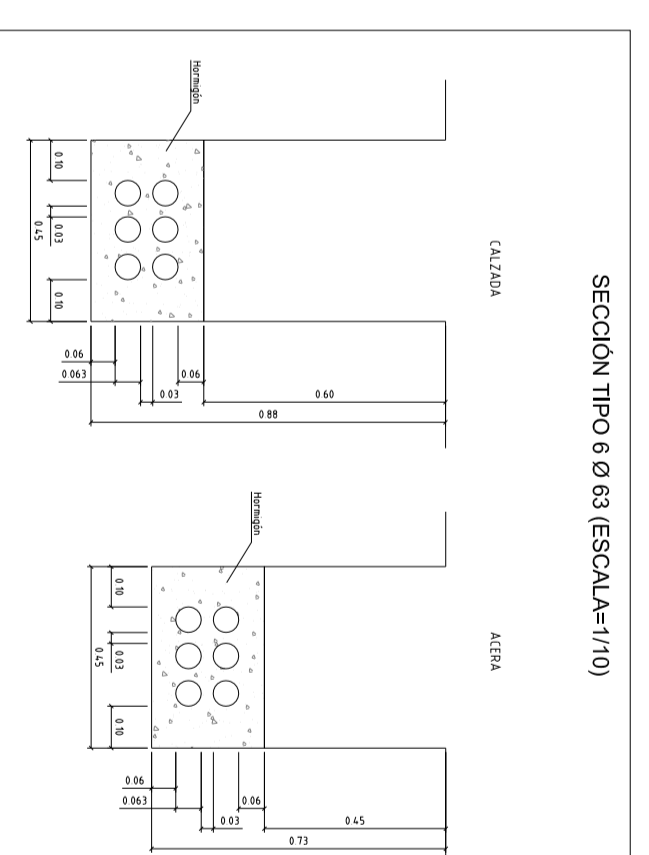
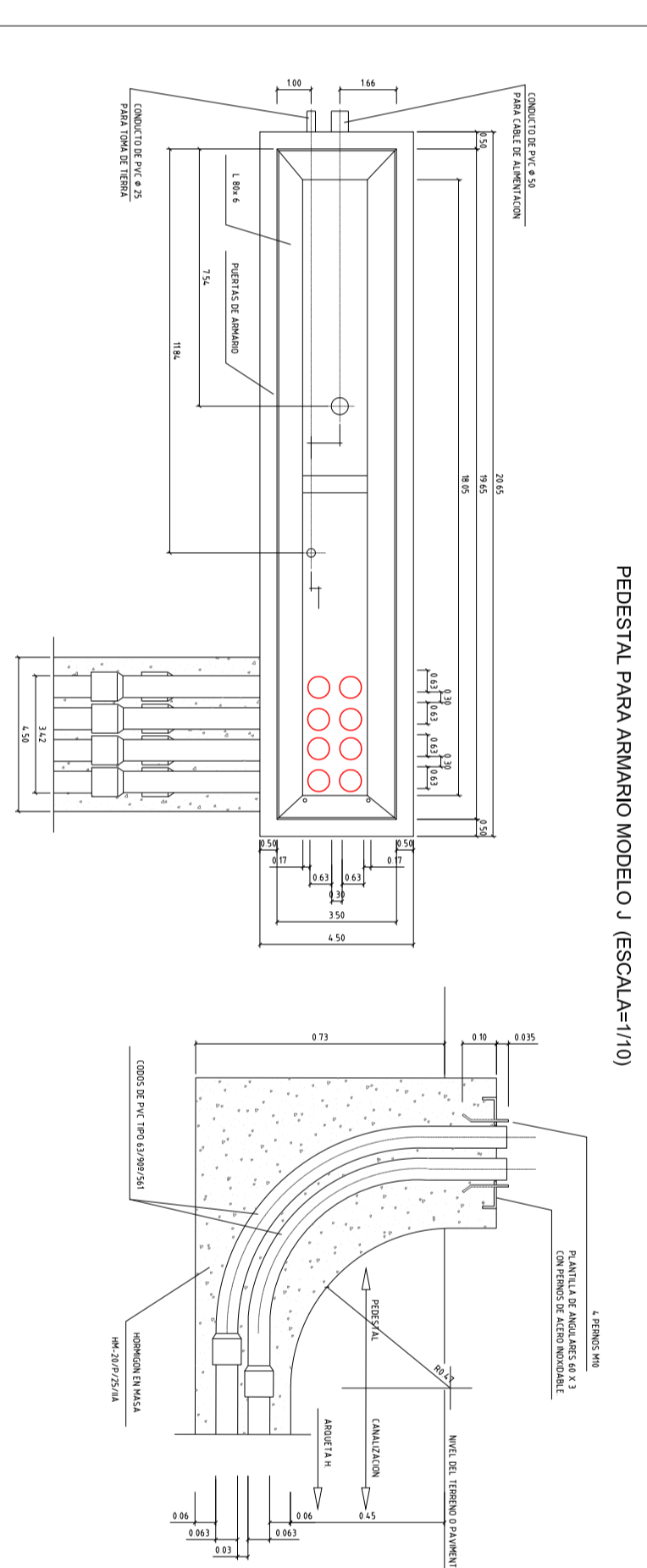
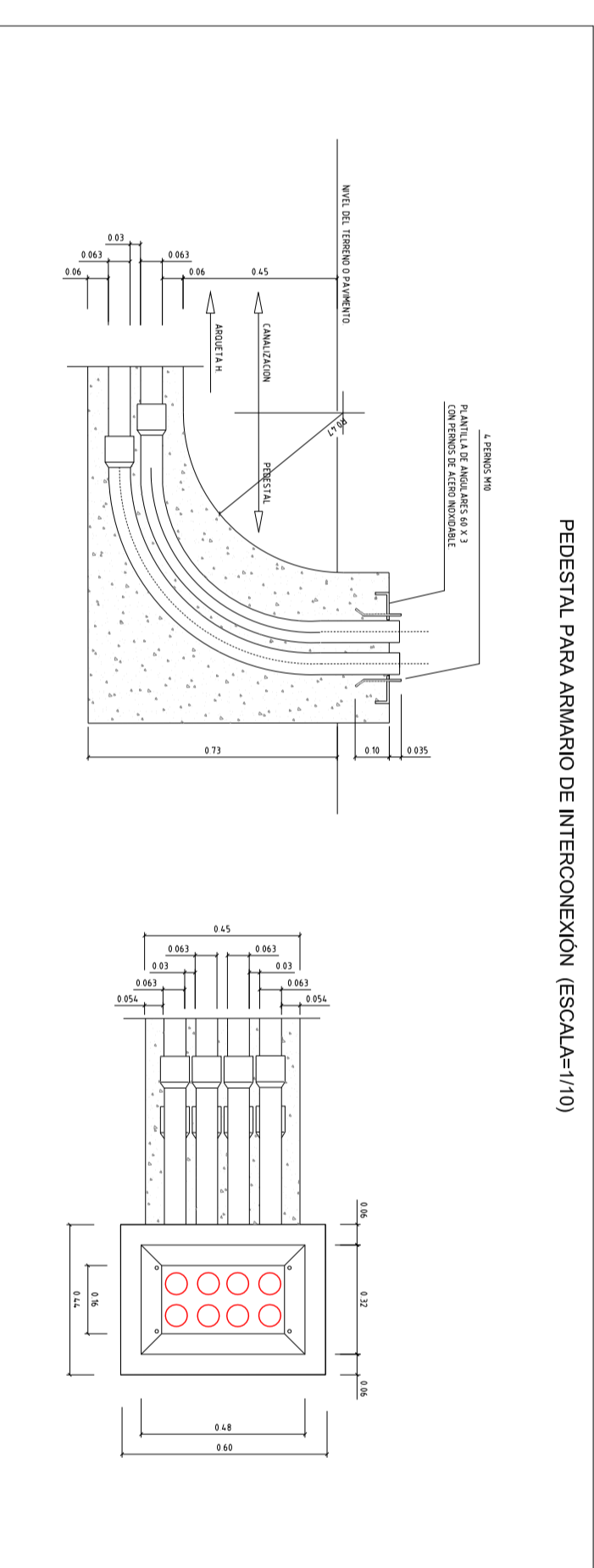
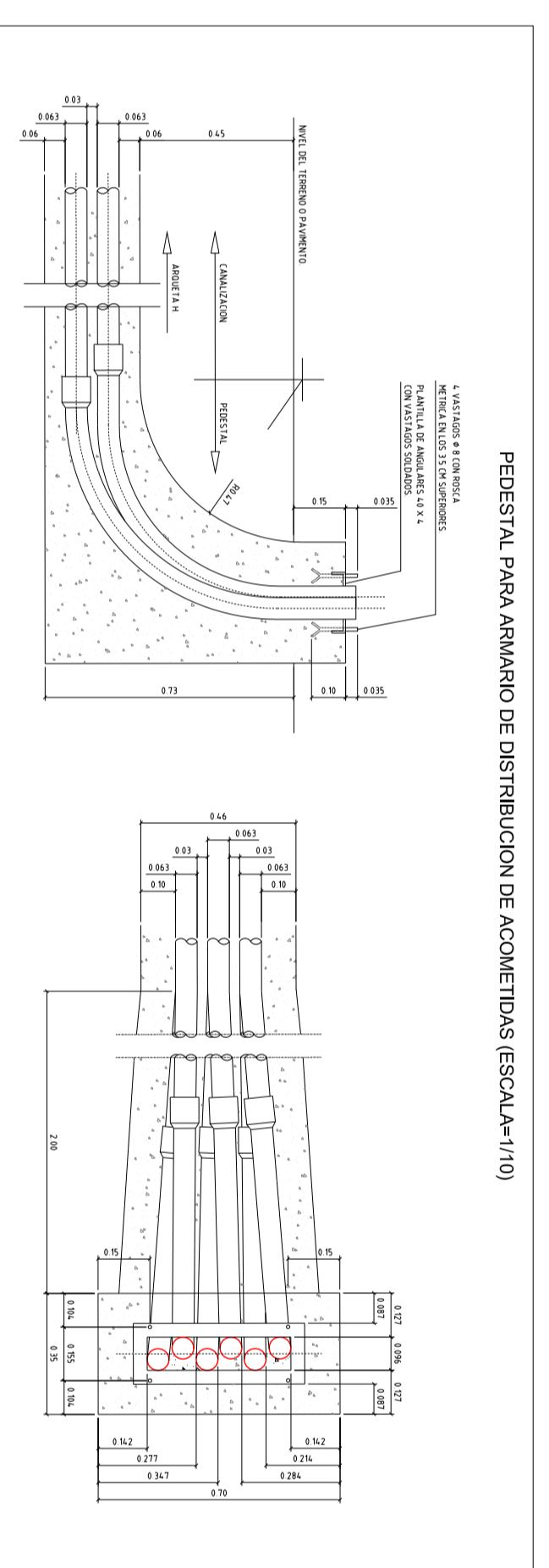
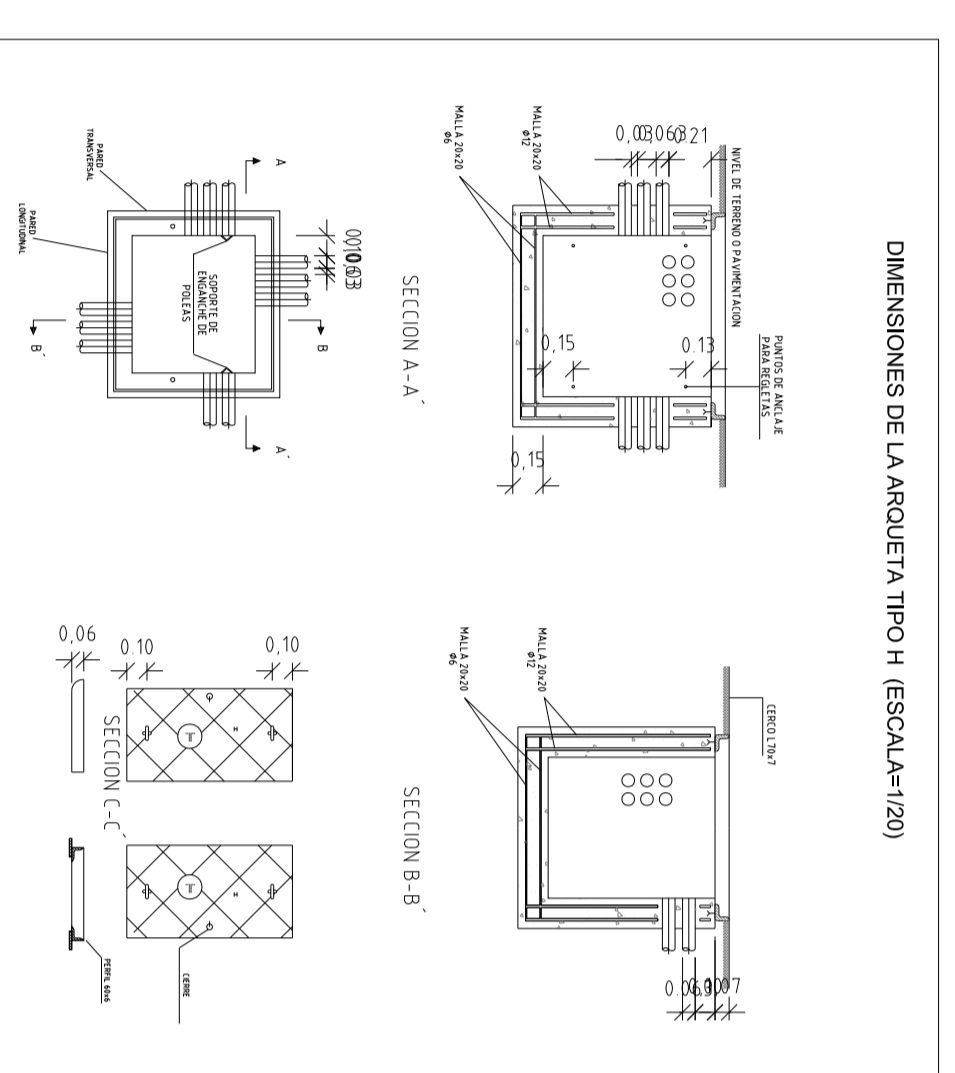
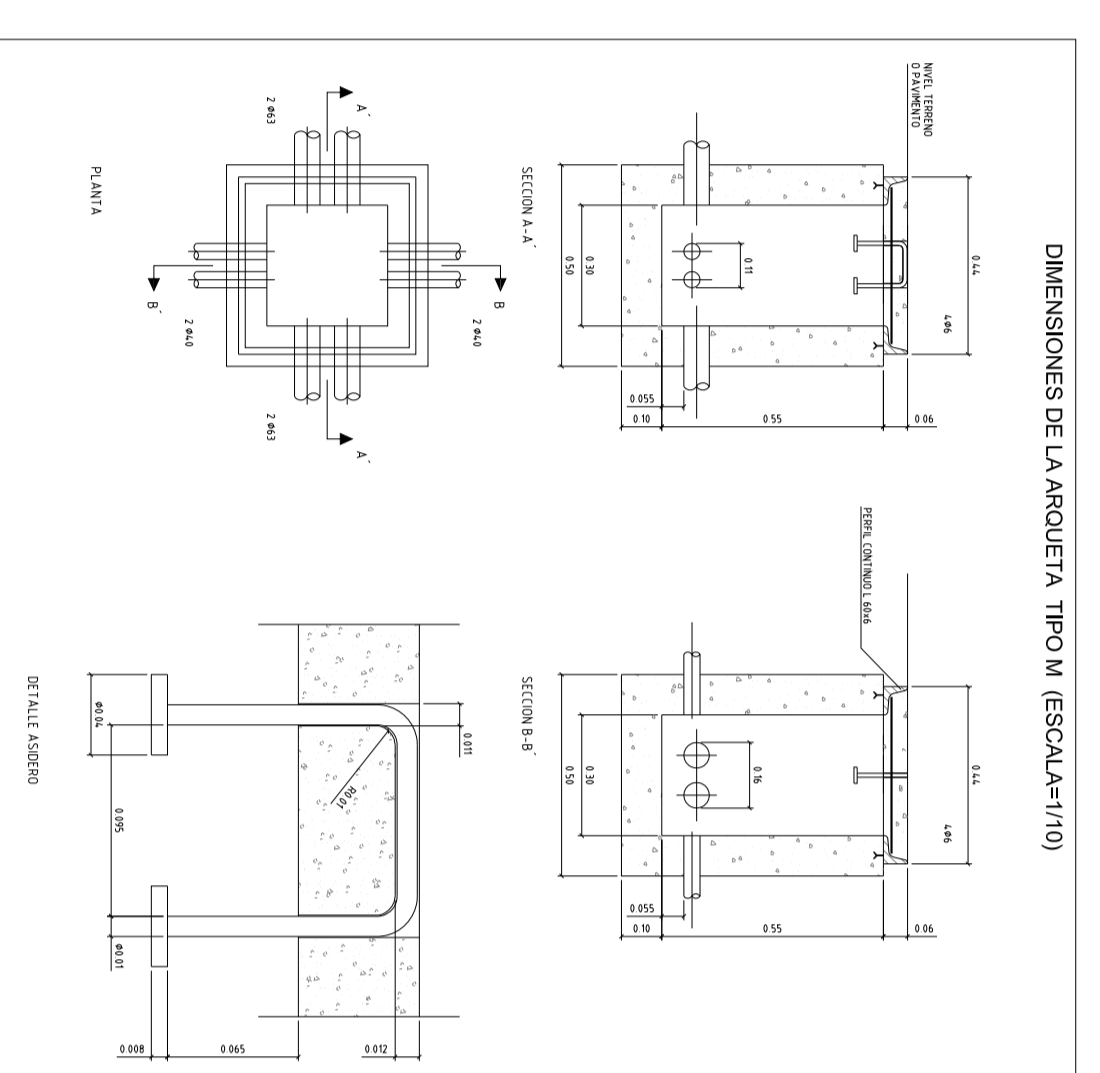
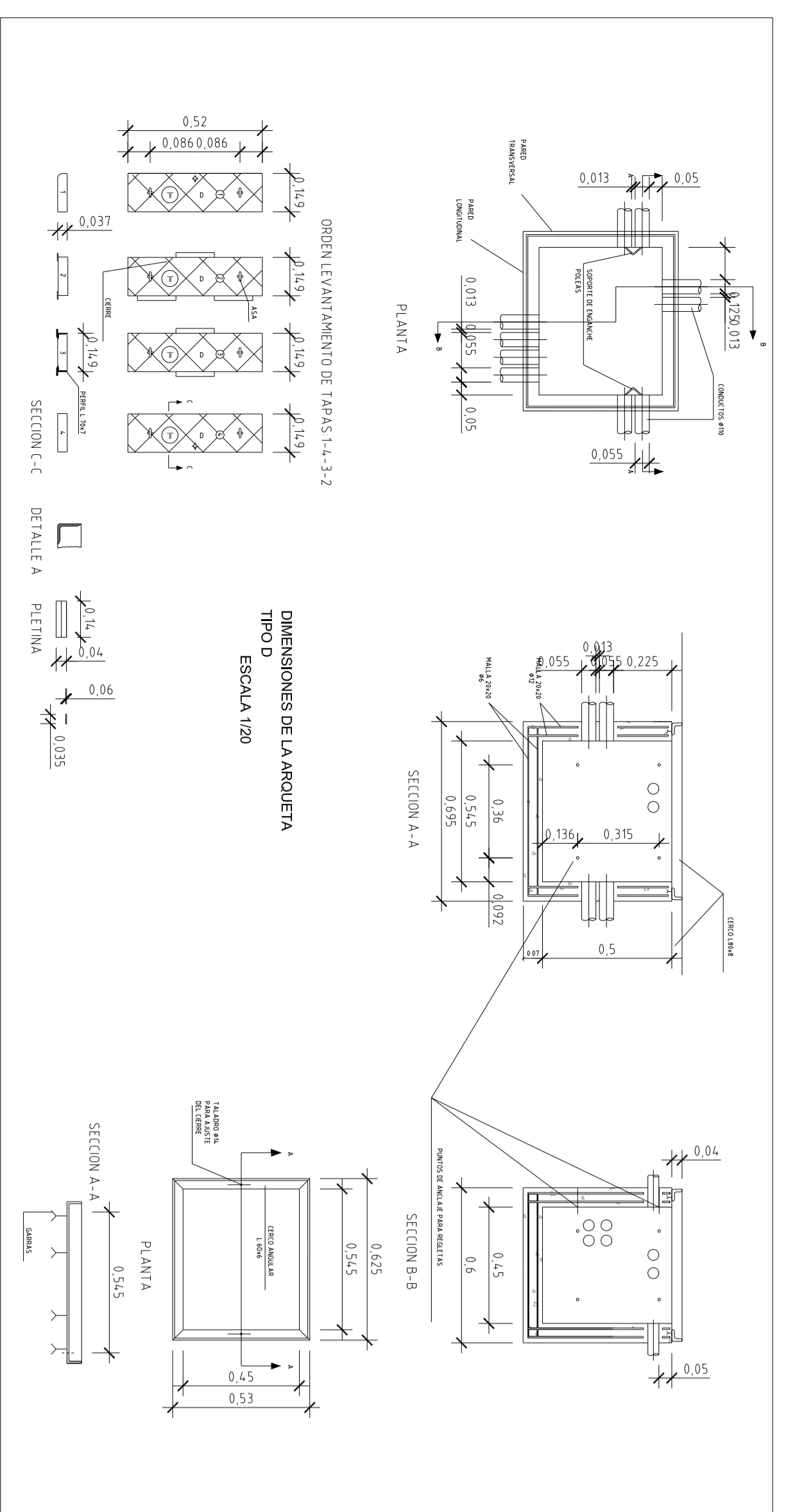
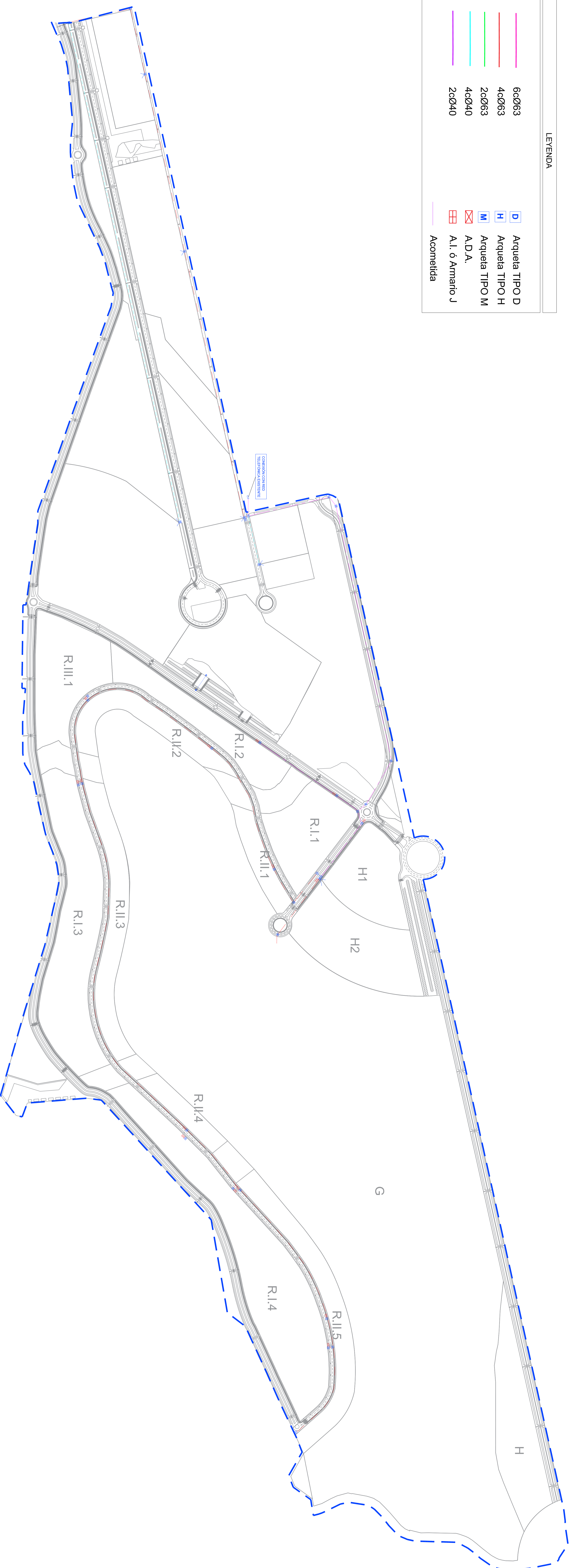

PROYECTO DE URBANIZACIÓN DEL SECTOR "PEGO GOLF" EN PEGO (ALICANTE).

REPRESENTA RED DE TELECOMUNICACIONES

| | | | | | |
|--------|--------|-------|--------------|----------|------|
| ESCALA | 1/3000 | FECHA | FEBRERO 2023 | Nº PLANO | P 11 |
|--------|--------|-------|--------------|----------|------|

PROPIEDAD CONSTRUCCIONES HISPANO GERMANAS S.A.

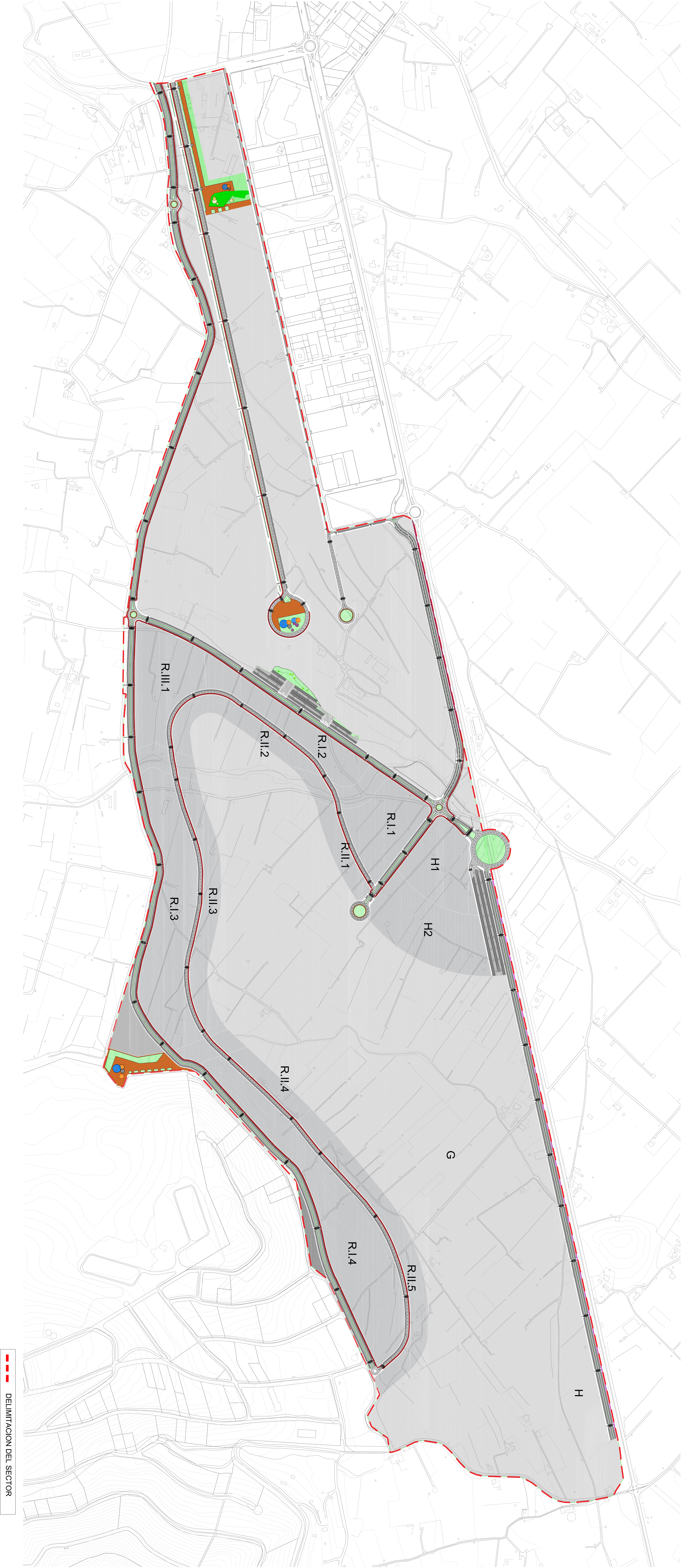

--- DELIMITACION DEL SECTOR

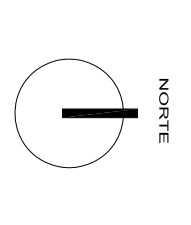
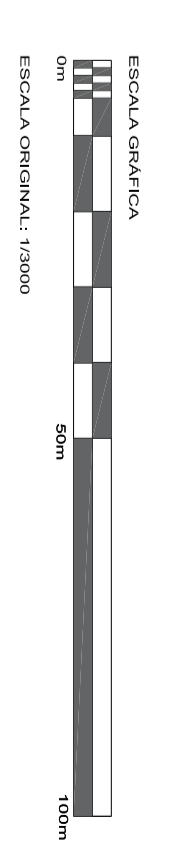

PROYECTO DE URBANIZACIÓN DEL SECTOR "PEGO GOLF" EN PEGO (ALICANTE).

| REPRESENTA | ESCALA | FECHA | Nº PLANO |
|------------|-------------|---------|----------|
| PAVIMENTOS | 1/3000 | FEBRERO | P 12 |
| | 1/500 | 2023 | |
| | ORIGINAL A0 | | |

PROPIEDAD
CONSTRUCCIONES HISPANO GERMANAS S.A.

SENALES DE PELIGRO
SIN ESCALA

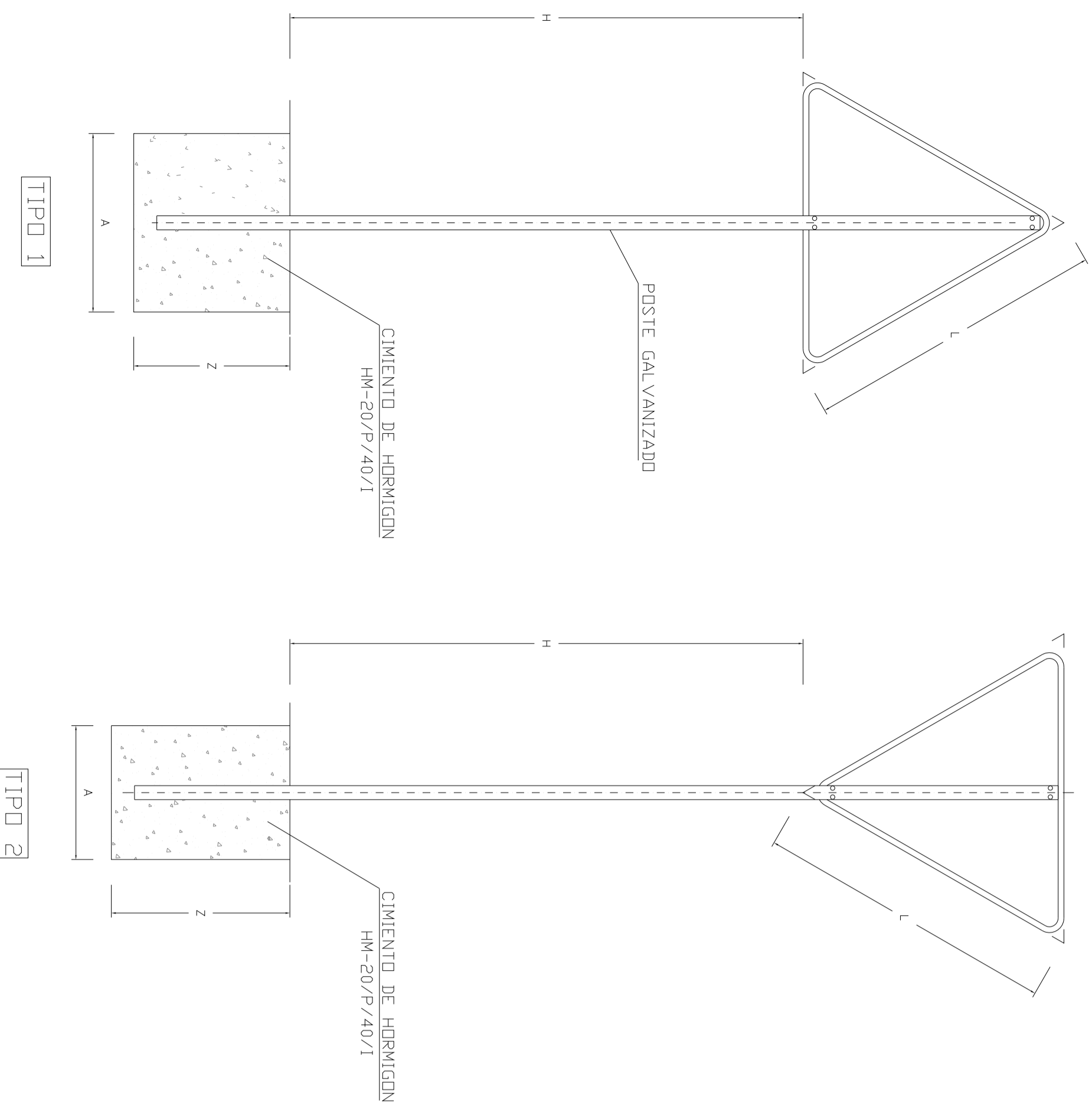

SENALES DE REGLAMENTACION
SIN ESCALA

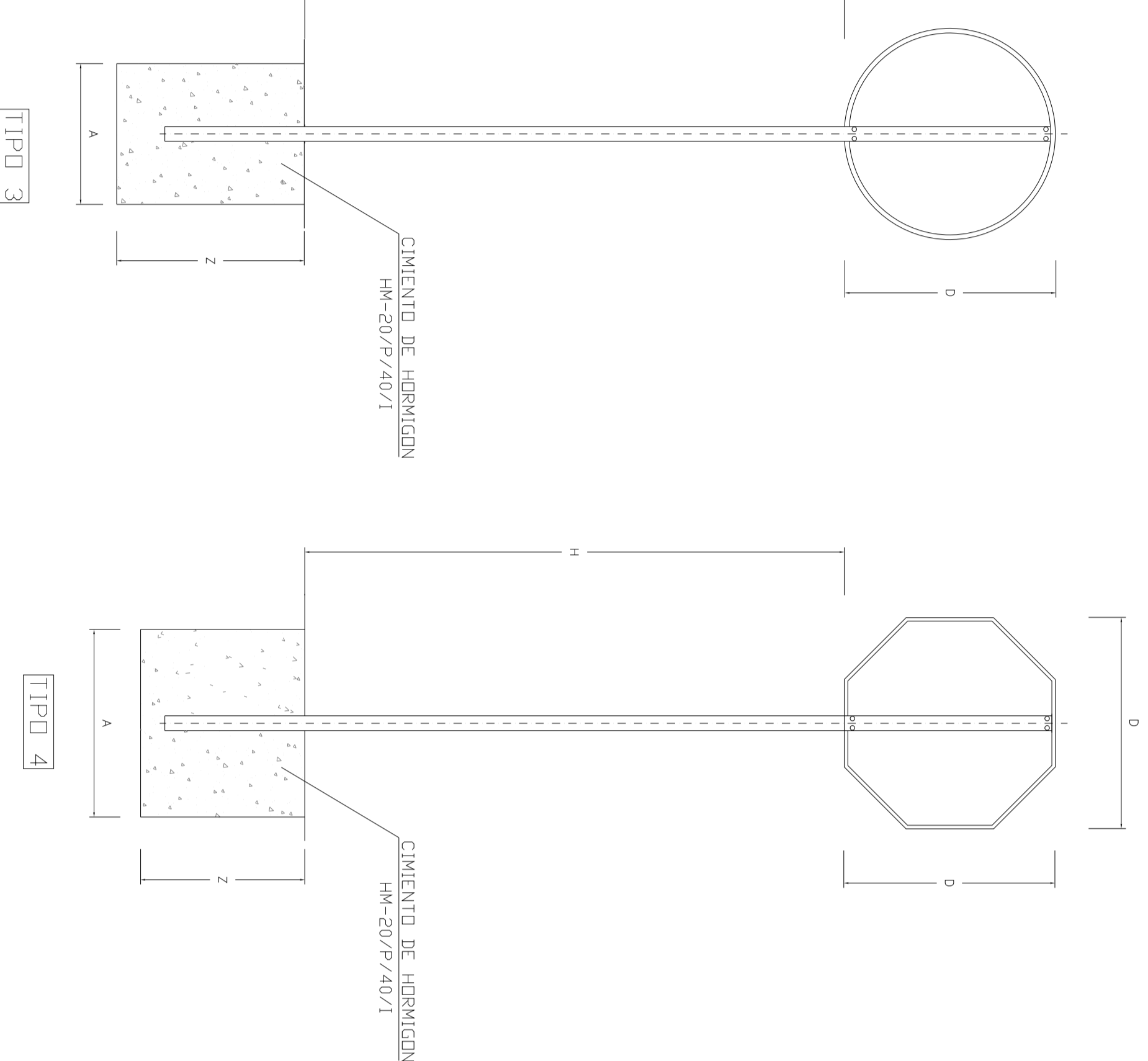

SENALES DE INDICACION
SIN ESCALA

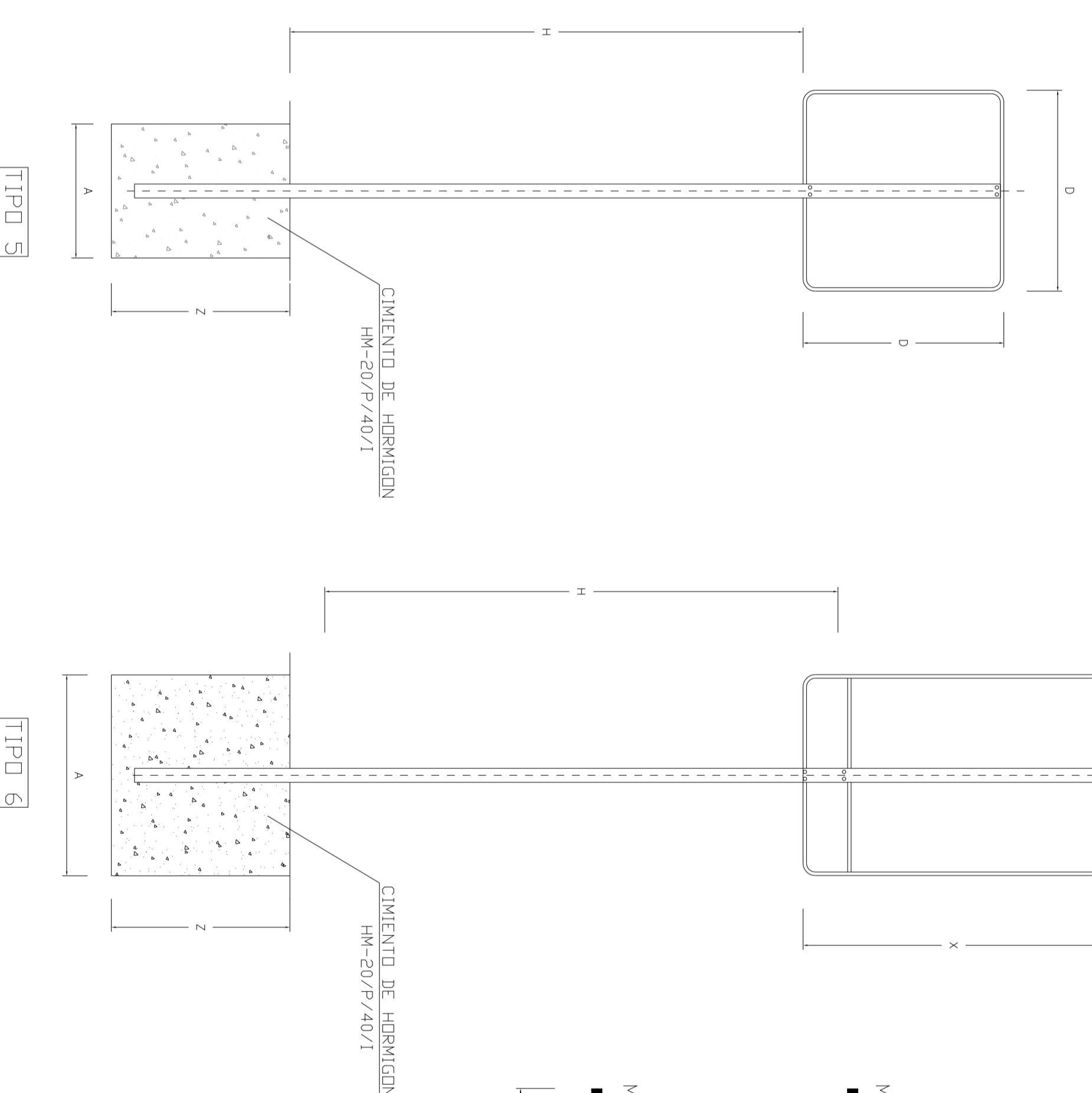

MARCAS LONGITUDINALES
ESCALA 1/100

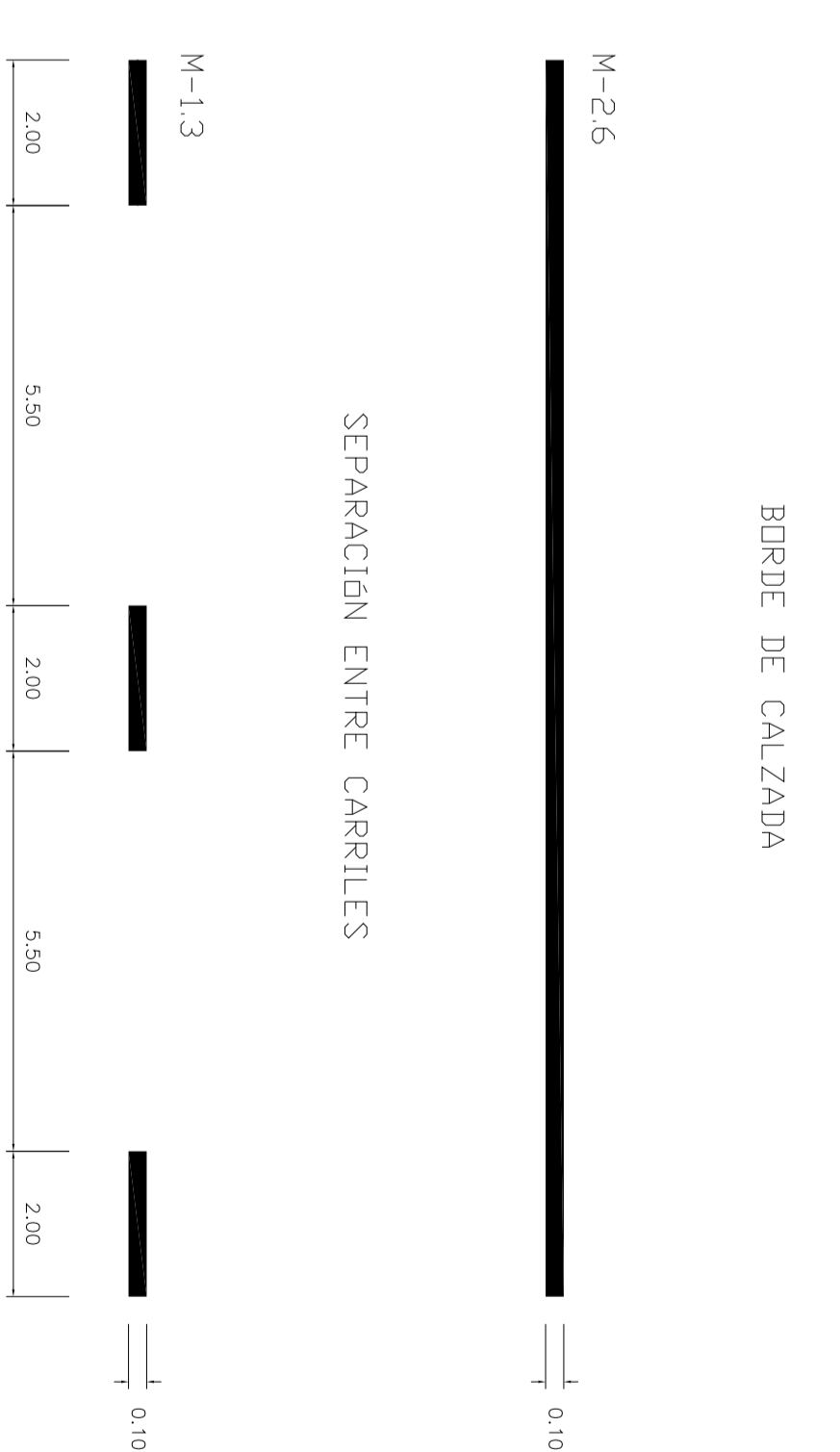

SENALES DE DIRECCION
SIN ESCALA
(COTAS EN mm)

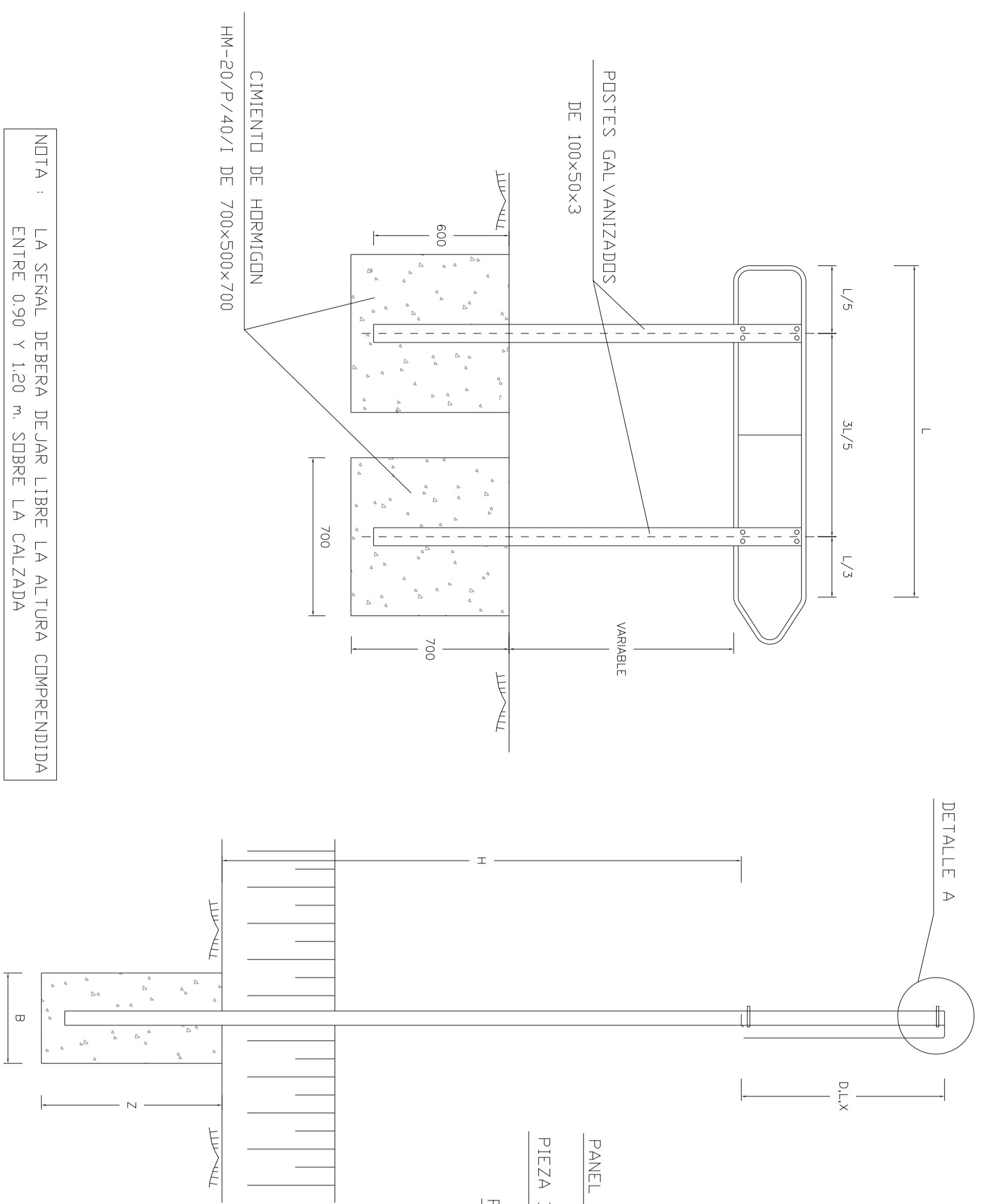

ALZADO LATERAL
SIN ESCALA
(COTAS EN mm)

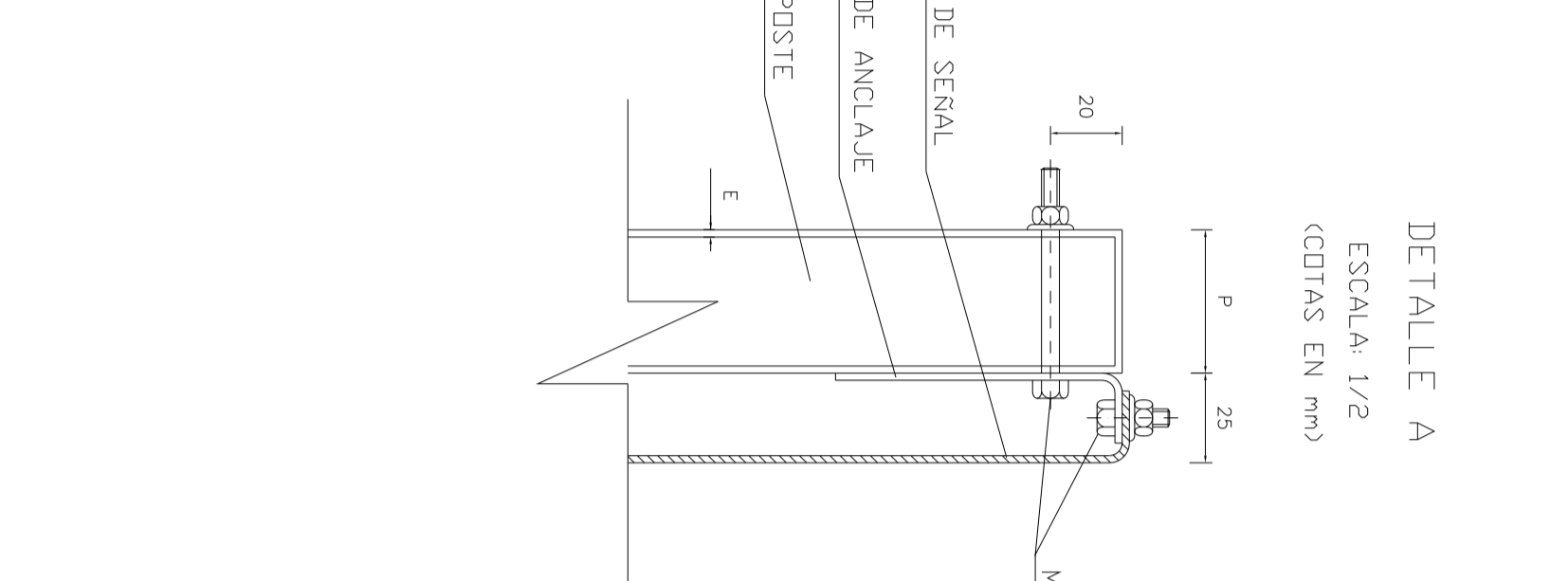

PIEZA DE ANCLAJE
ESCALA 1/2
(COTAS EN mm)

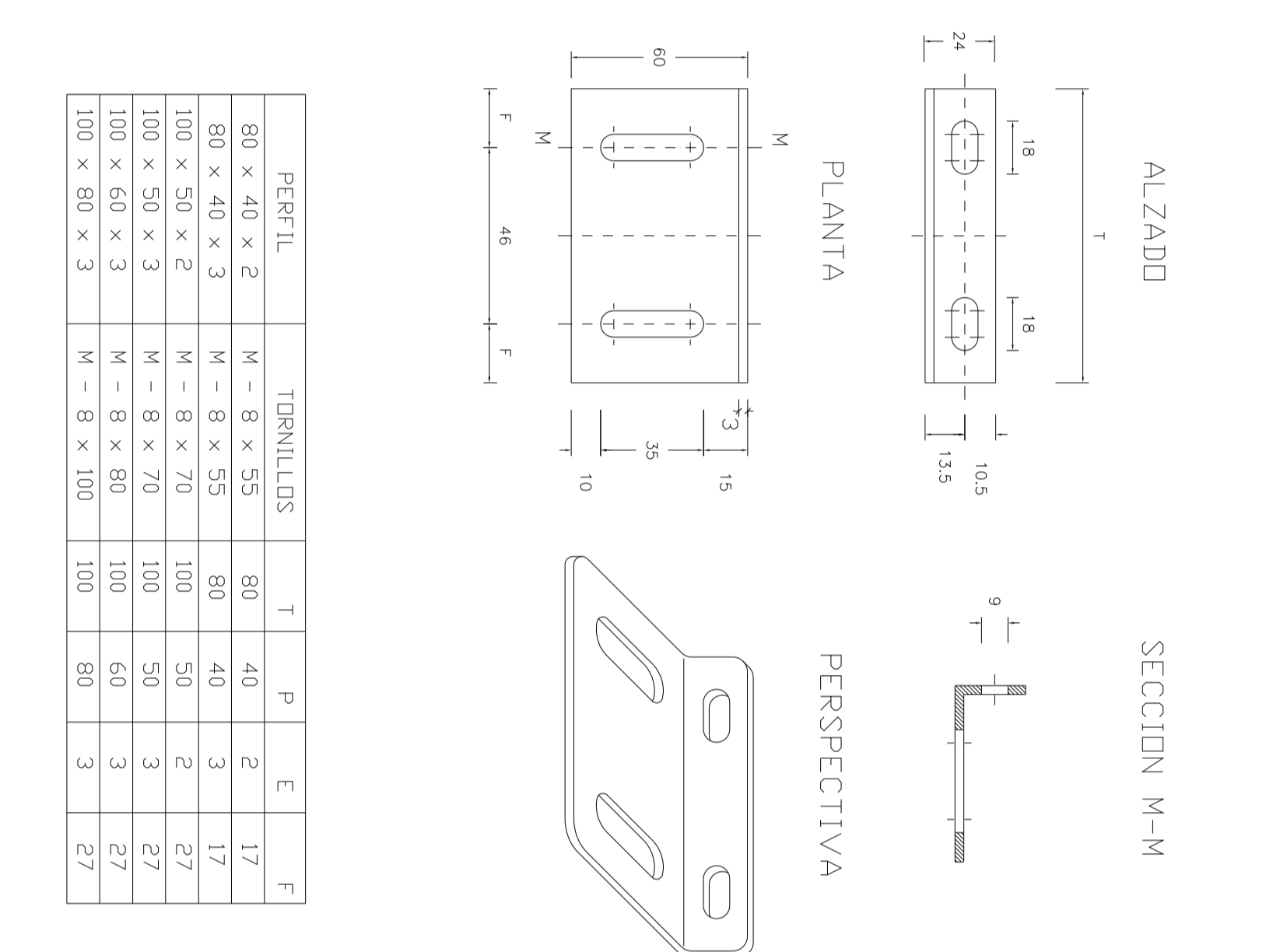

SENAL TIPO M-6.4
ESCALA 1/50

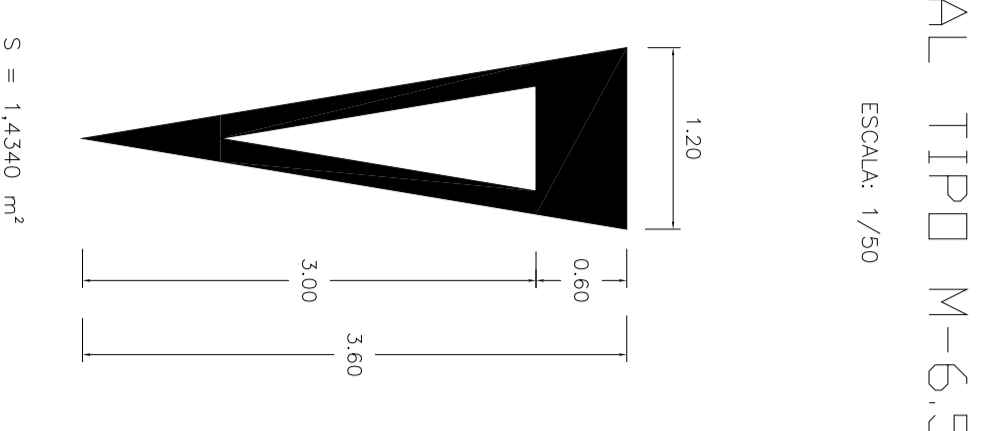
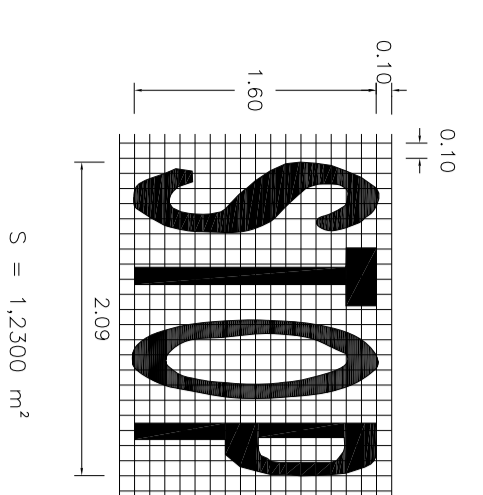

SENAL TIPO M-6.5
ESCALA 1/50

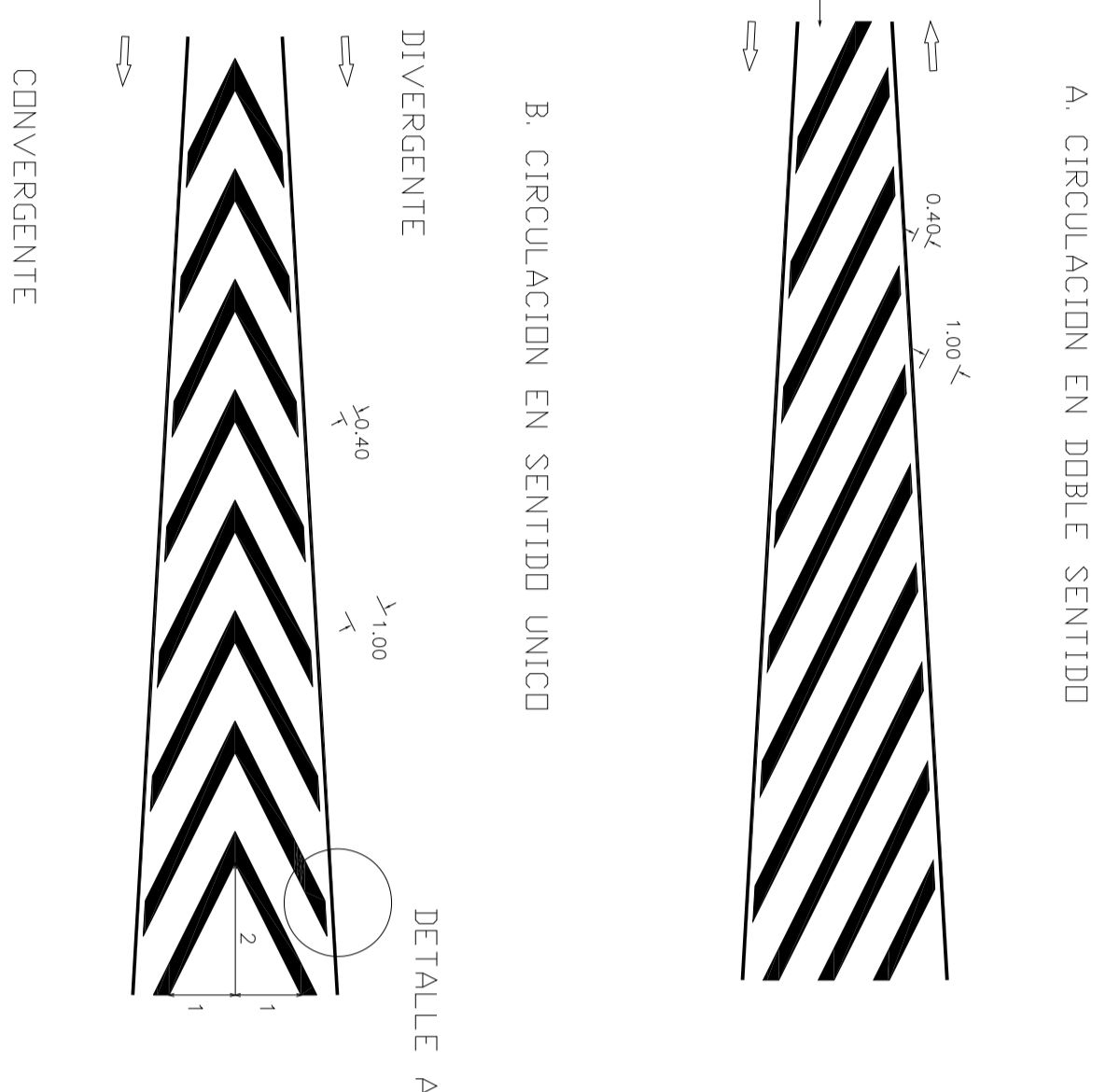

SENALES TIPO M-7.2
ESCALA 1/200

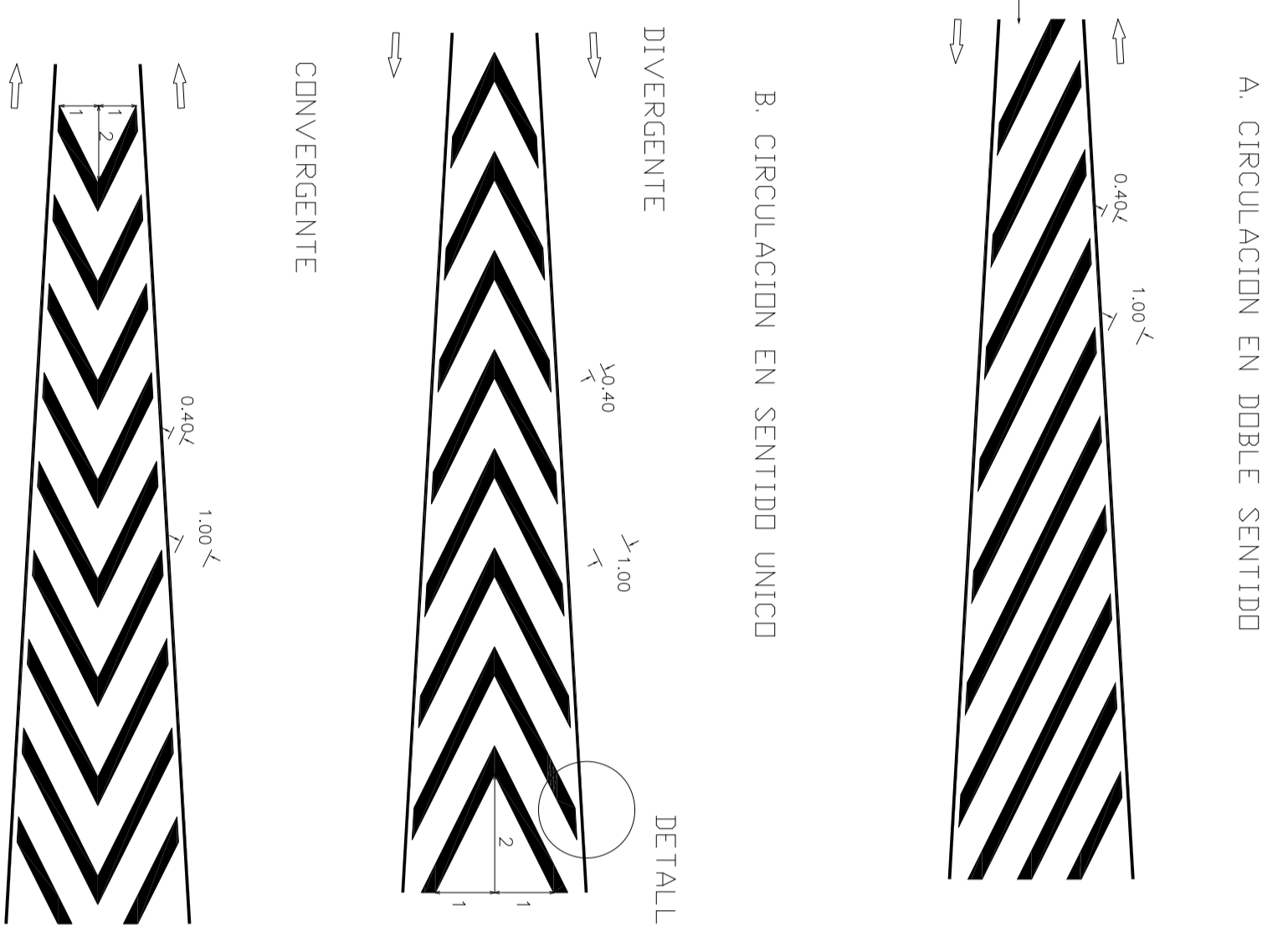

SENALES TIPO M-5.2
ESCALA 1/50

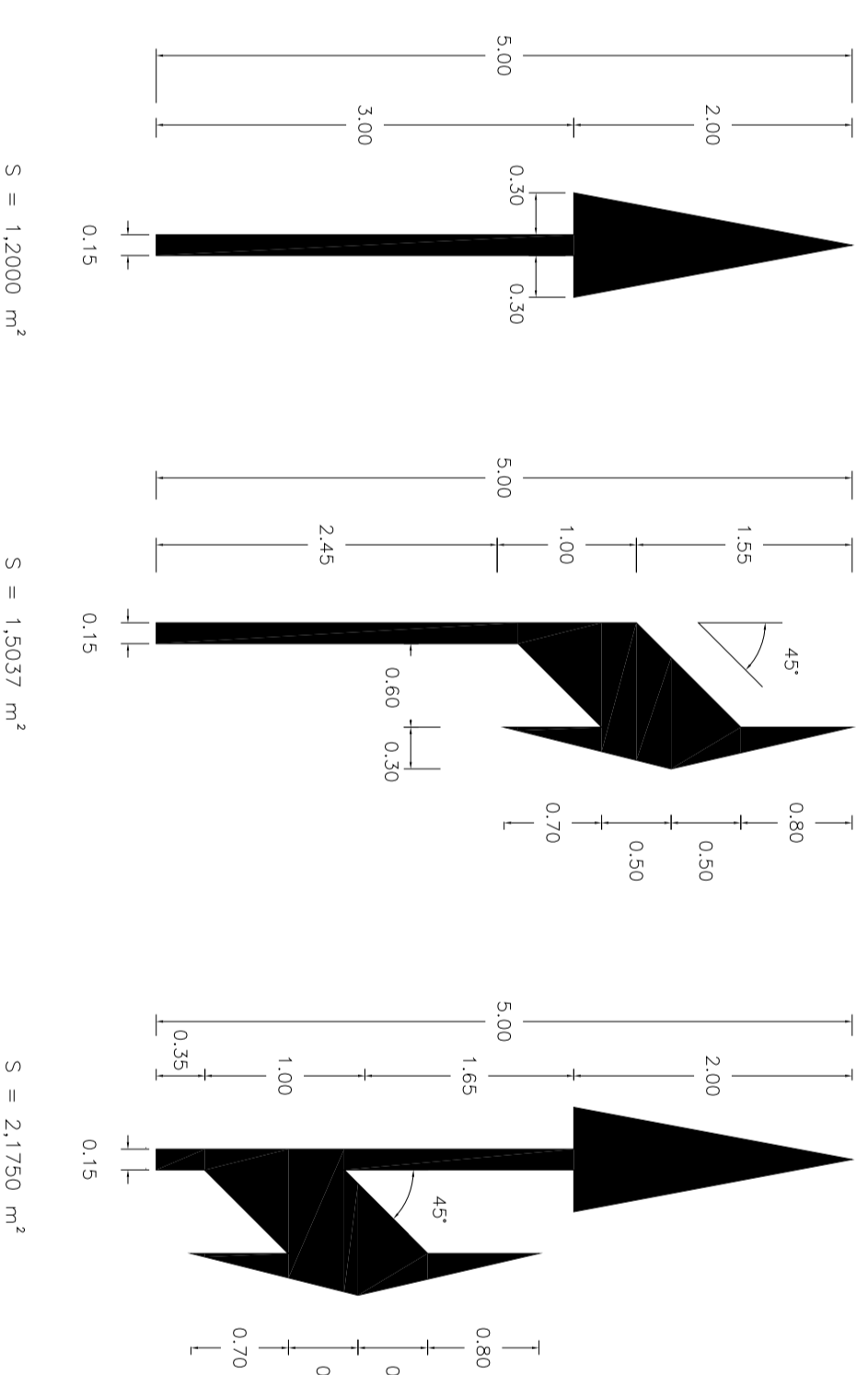

CICLO-RUTA
SIN ESCALA

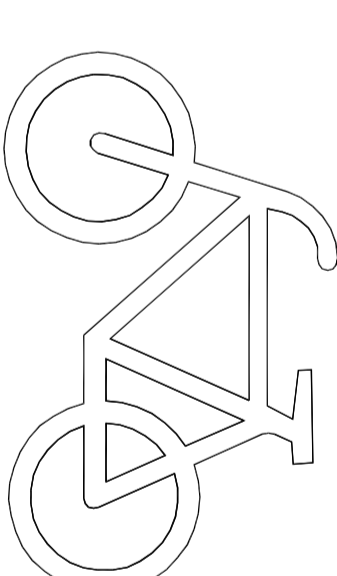

DETALLE A
ESCALA 1/20

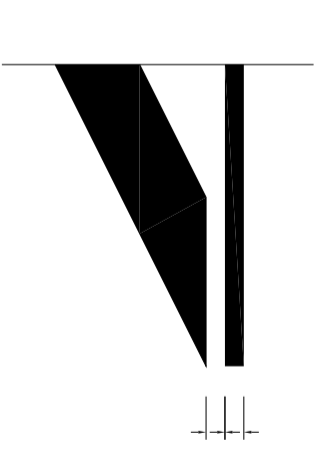

ANCHURA DE TRAZO 10 cm

NOTA EN ZONA URBANA, SI LA SENAL SE SITUASE SOBRE ACERAS LA DIFERENCIA ENTRE EL BORDE INFERIOR DE LA SENAL Y EL BORDE SUPERIOR DEL SILLON DEBERIA SER DE 5 CM M.

M-4.1



LINEA DE DETENCION

M-4.2

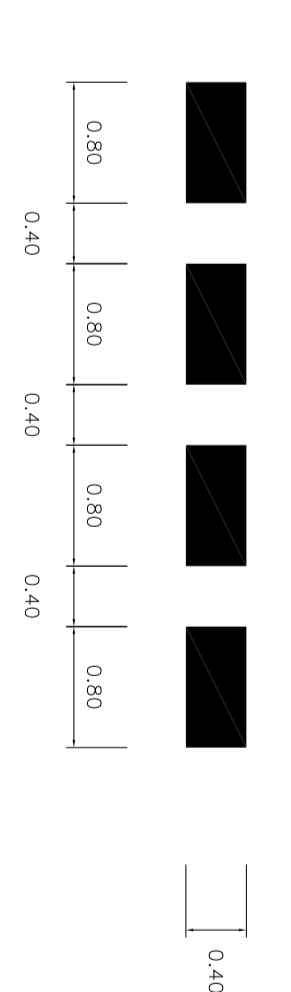

LINEA DE CEDA EL PASO

TERMINACION ISLETA
ESCALA 1/20

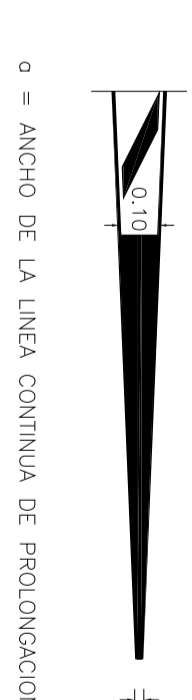

φ = ANCHO DE LA LINEA CONTINUA DE PROLONGACION

PROYECTO DE URBANIZACIÓN DEL SECTOR "PEGO GOLF" EN PEGO (ALICANTE).

| | | | |
|--------------|-------------|--------------|----------|
| REPRESENTA | ESCALA | FECHA | Nº PLANO |
| SEÑALIZACIÓN | SIE | FEBRERO 2023 | P 13 |
| | ORIGINAL NO | | |

PROPIEDAD
CONSTRUCCIONES HISPANO GERMANAS S.A.