

MATERIAL		DESCRIPCIÓN	
1	ALUMINIO	PERFILES	ALISO FINAL
2	VIDRIO	6+6	6+6
3	ACABADO	BLANCO	BLANCO

MATERIAL		DESCRIPCIÓN	
1	ALUMINIO	PERFILES	ALISO FINAL
2	VIDRIO	6+6	6+6
3	ACABADO	BLANCO	BLANCO

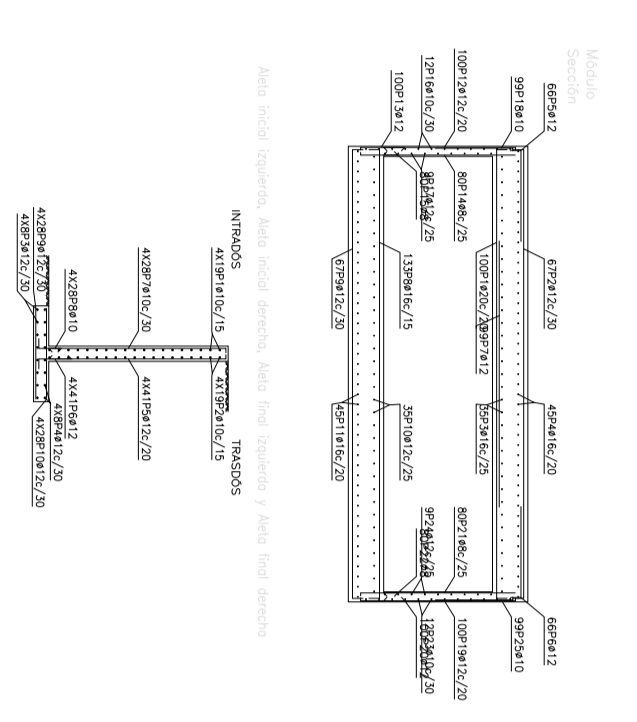
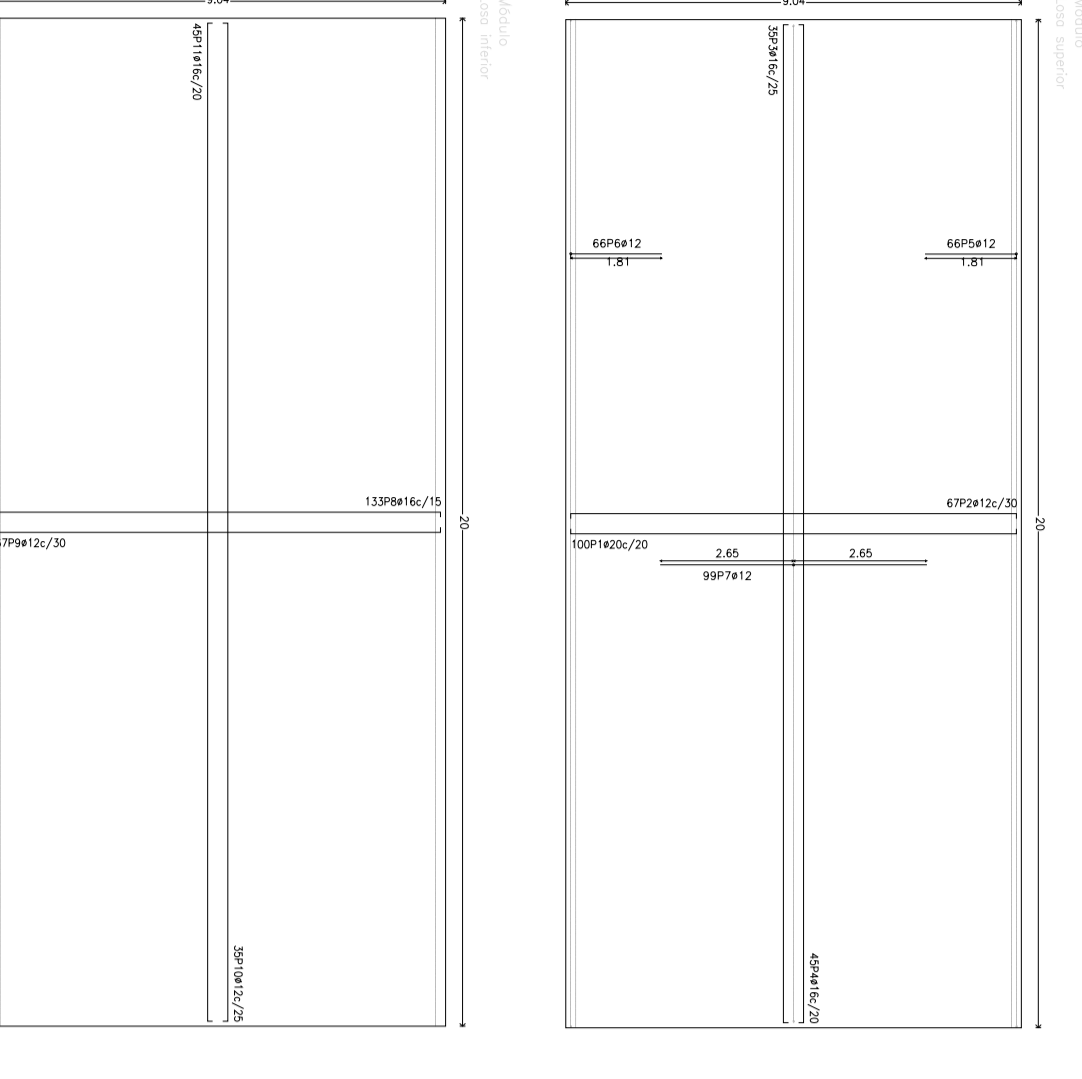
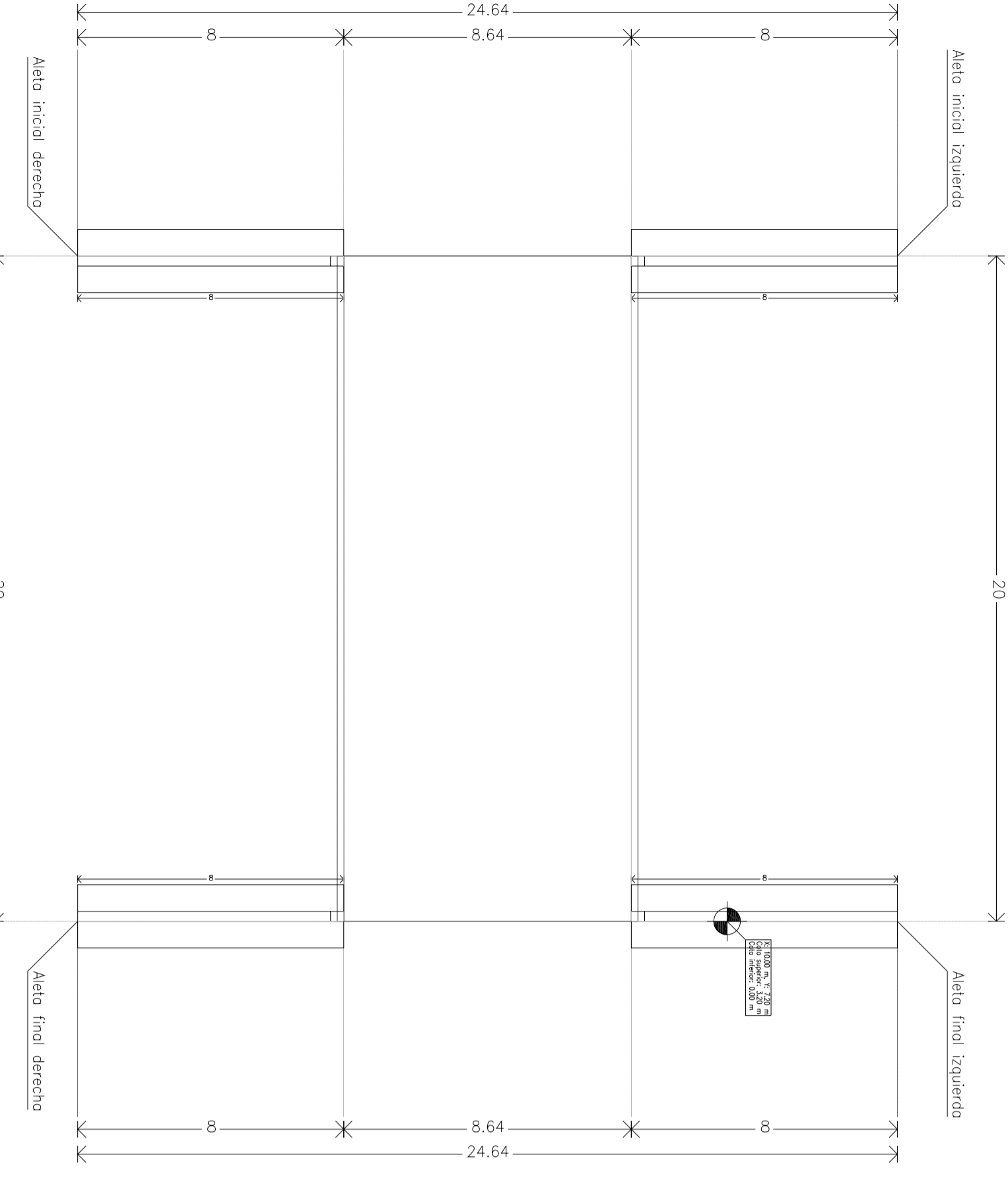
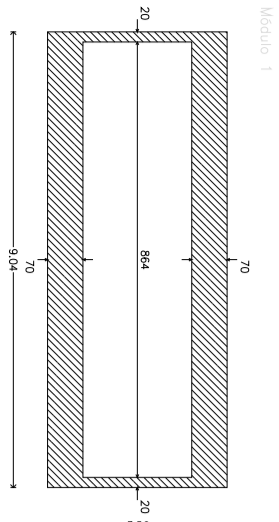
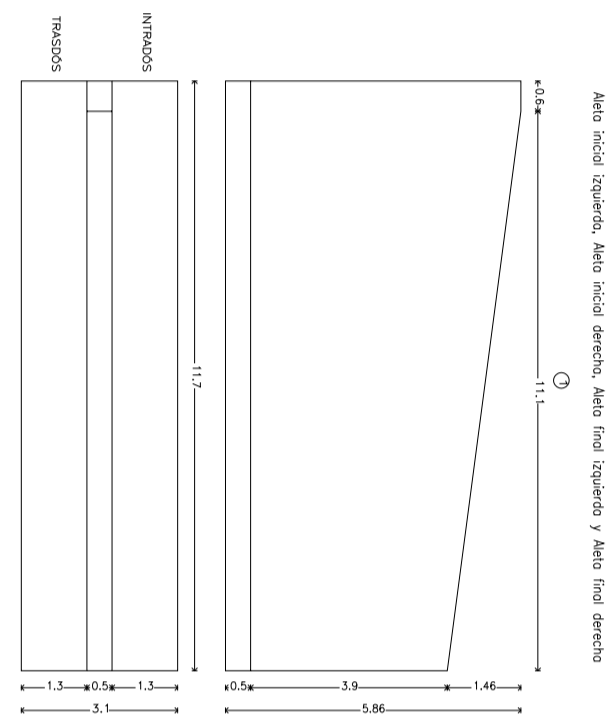

MATERIAL		DESCRIPCIÓN	
1	ALUMINIO	PERFILES	ALISO FINAL
2	VIDRIO	6+6	6+6
3	ACABADO	BLANCO	BLANCO

MATERIAL		DESCRIPCIÓN	
1	ALUMINIO	PERFILES	ALISO FINAL
2	VIDRIO	6+6	6+6
3	ACABADO	BLANCO	BLANCO

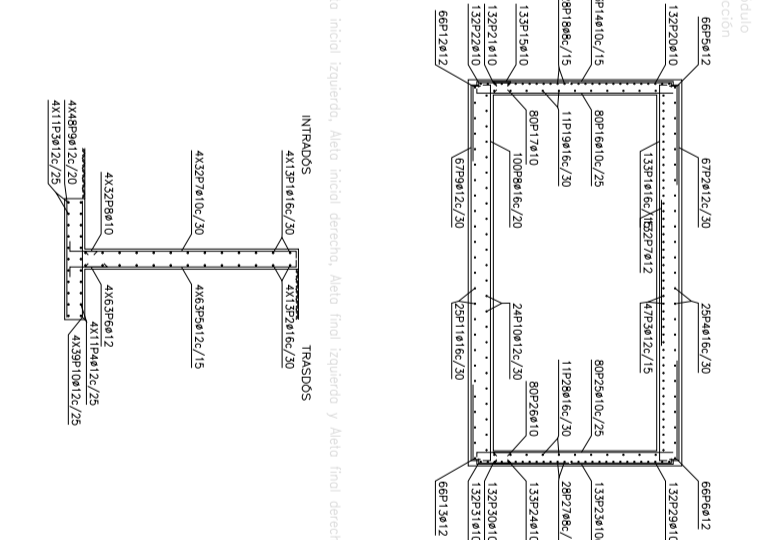
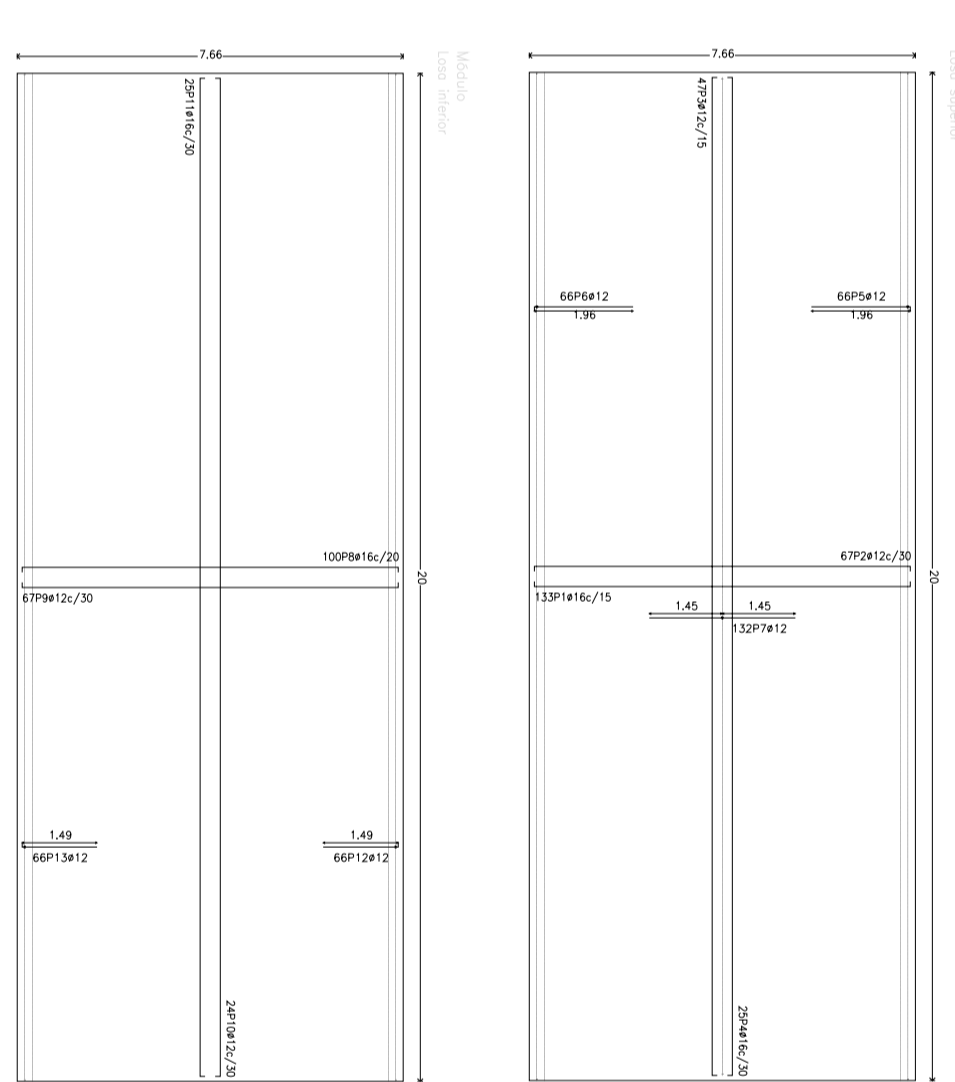
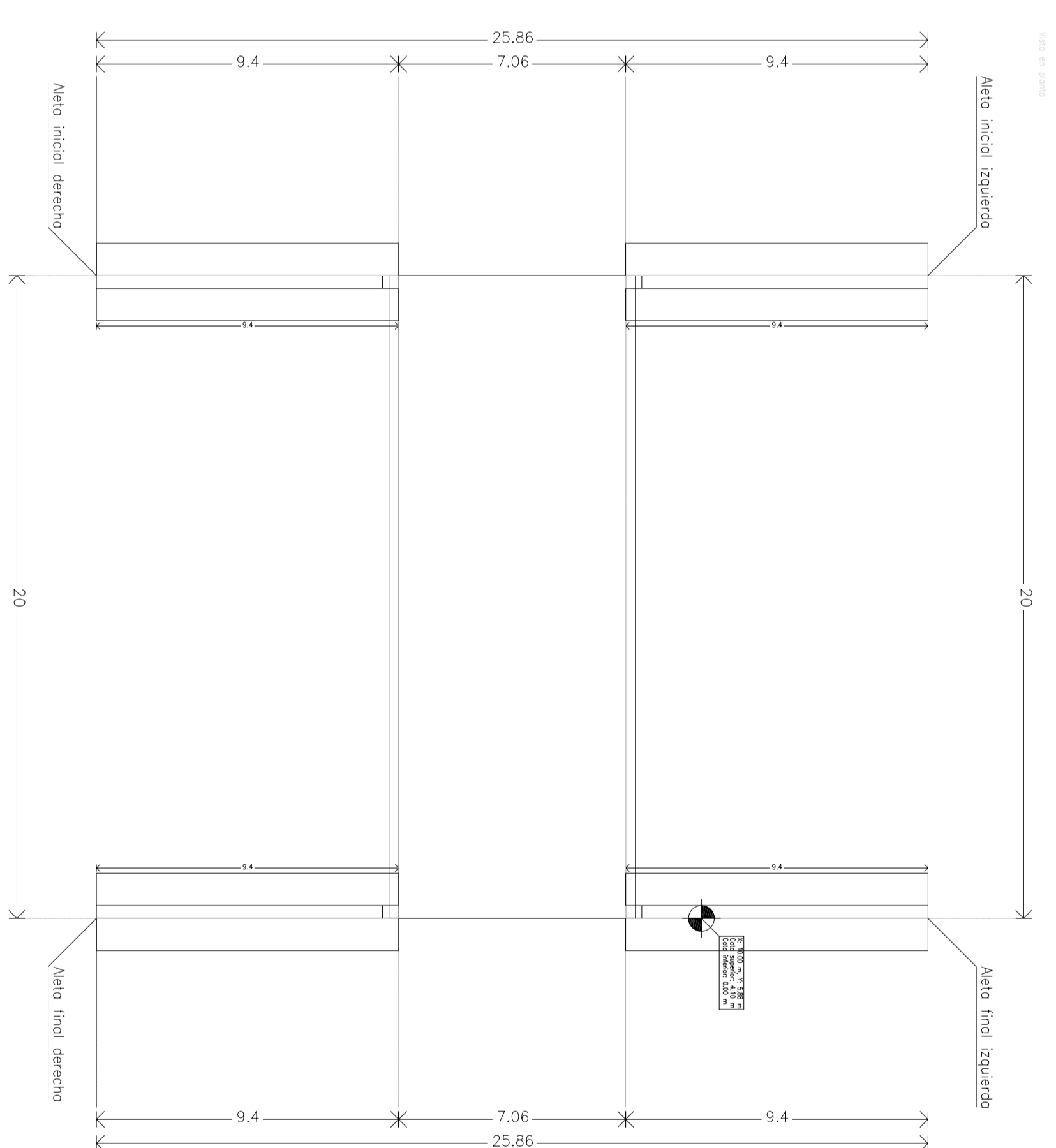
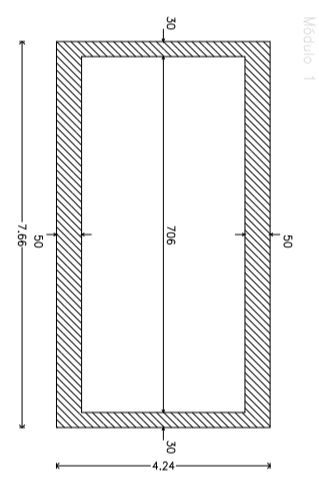
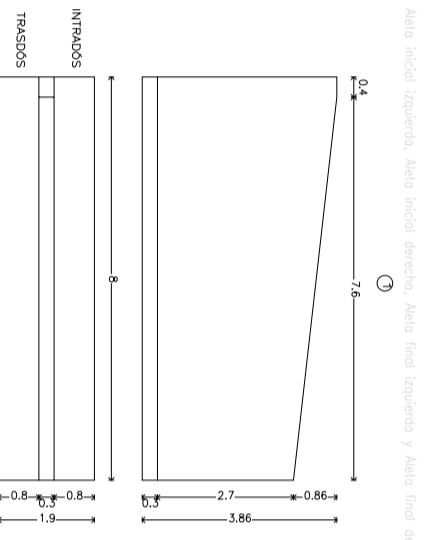

MATERIAL		DESCRIPCIÓN	
1	ALUMINIO	PERFILES	ALISO FINAL
2	VIDRIO	6+6	6+6
3	ACABADO	BLANCO	BLANCO

MATERIAL		DESCRIPCIÓN	
1	ALUMINIO	PERFILES	ALISO FINAL
2	VIDRIO	6+6	6+6
3	ACABADO	BLANCO	BLANCO

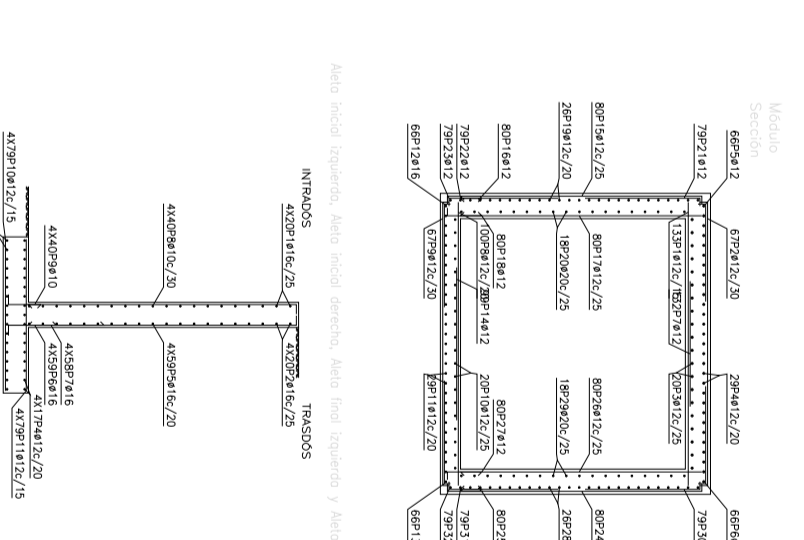
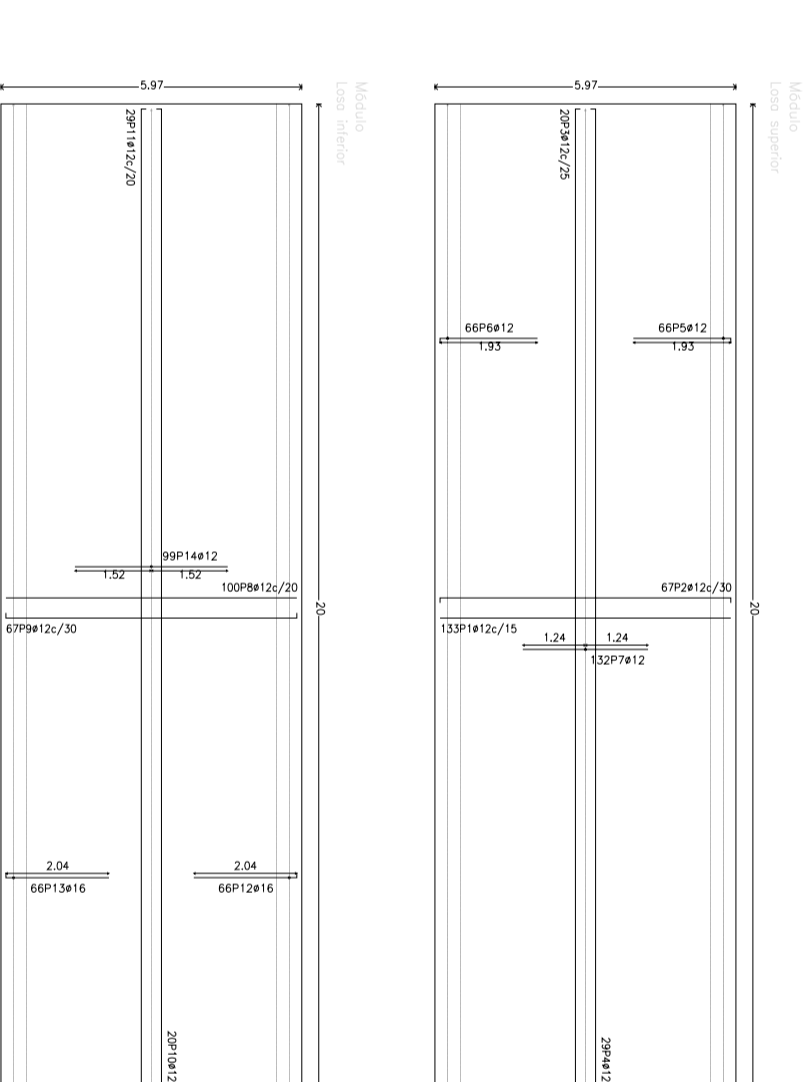
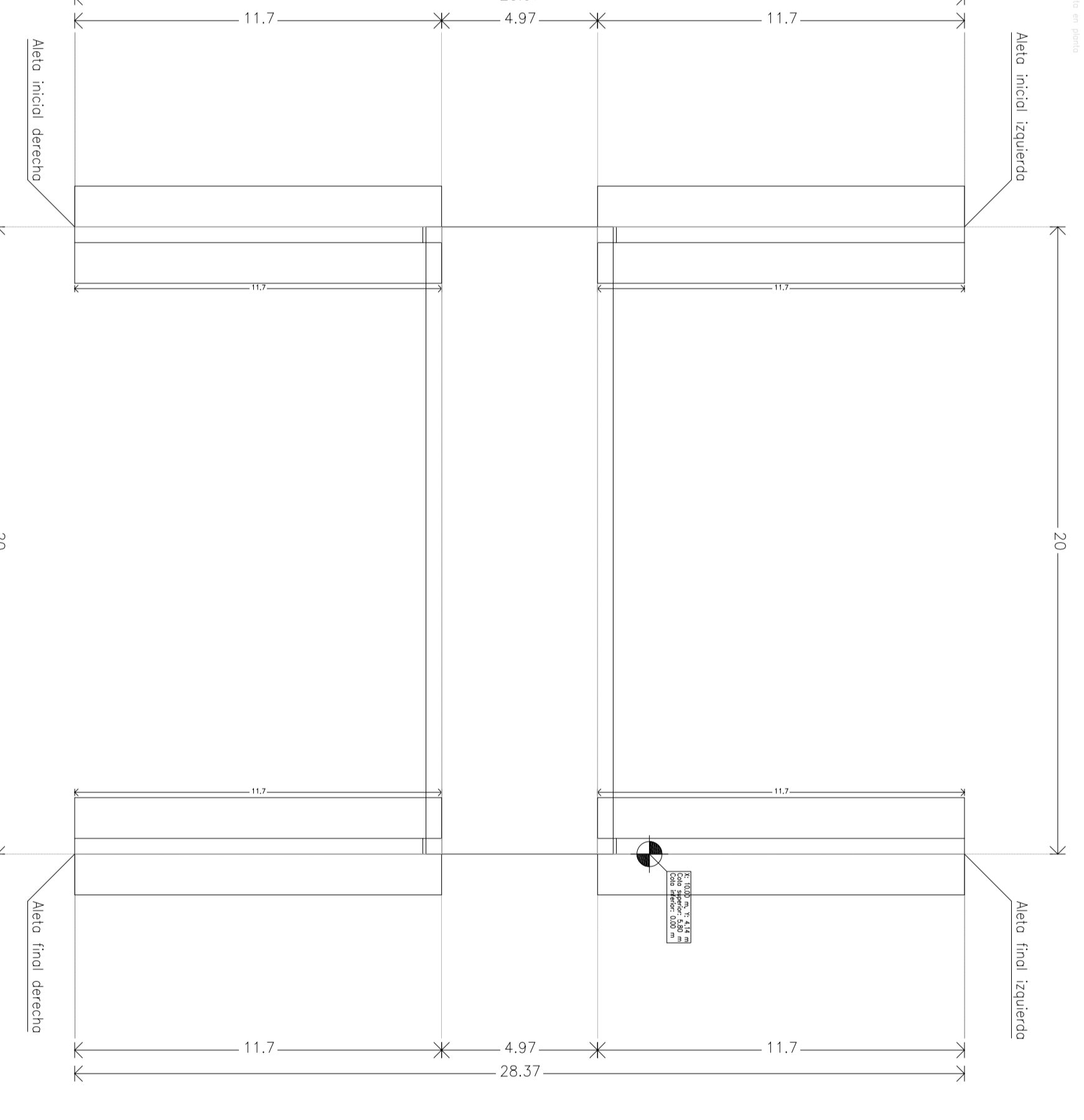
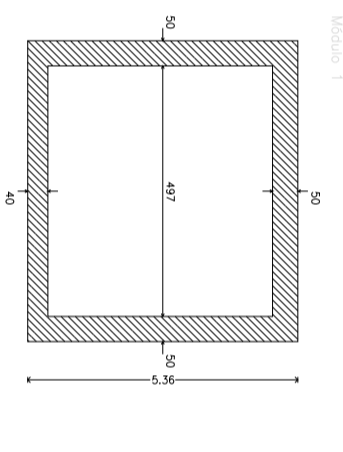
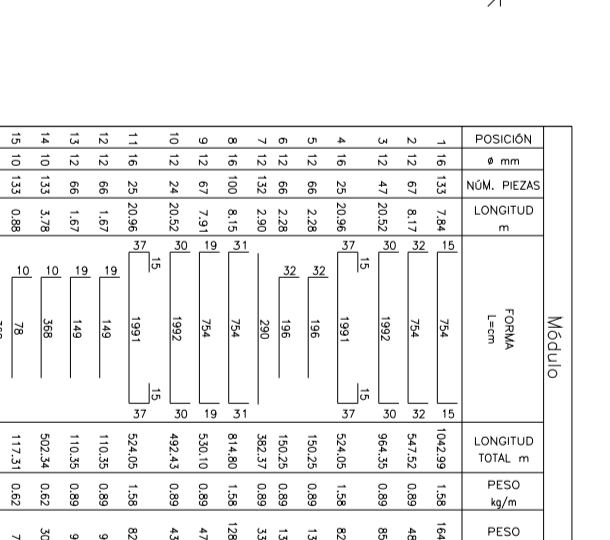

MATERIAL		DESCRIPCIÓN	
1	ALUMINIO	PERFILES	ALISO FINAL
2	VIDRIO	6+6	6+6
3	ACABADO	BLANCO	BLANCO

MATERIAL		DESCRIPCIÓN	
1	ALUMINIO	PERFILES	ALISO FINAL
2	VIDRIO	6+6	6+6
3	ACABADO	BLANCO	BLANCO

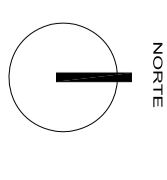
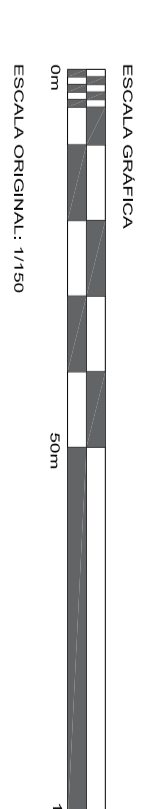
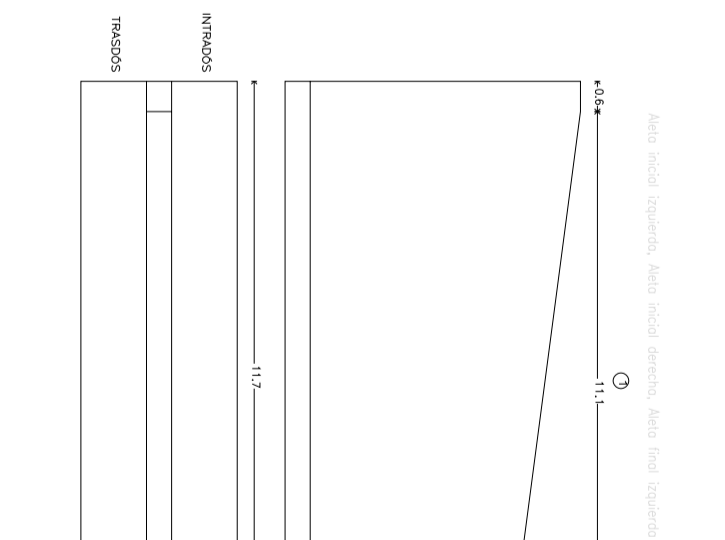

PROYECTO DE URBANIZACIÓN DEL SECTOR "PEGO GOLF" EN PEGO (ALICANTE).

REPRESENTA OBRAS DE PASO
ESCALA 1/150
FECHA FEBRERO 2023
Nº PLANO P 19.03

PROPIEDAD CONSTRUCCIONES HISPANO GERMANAS S.A.

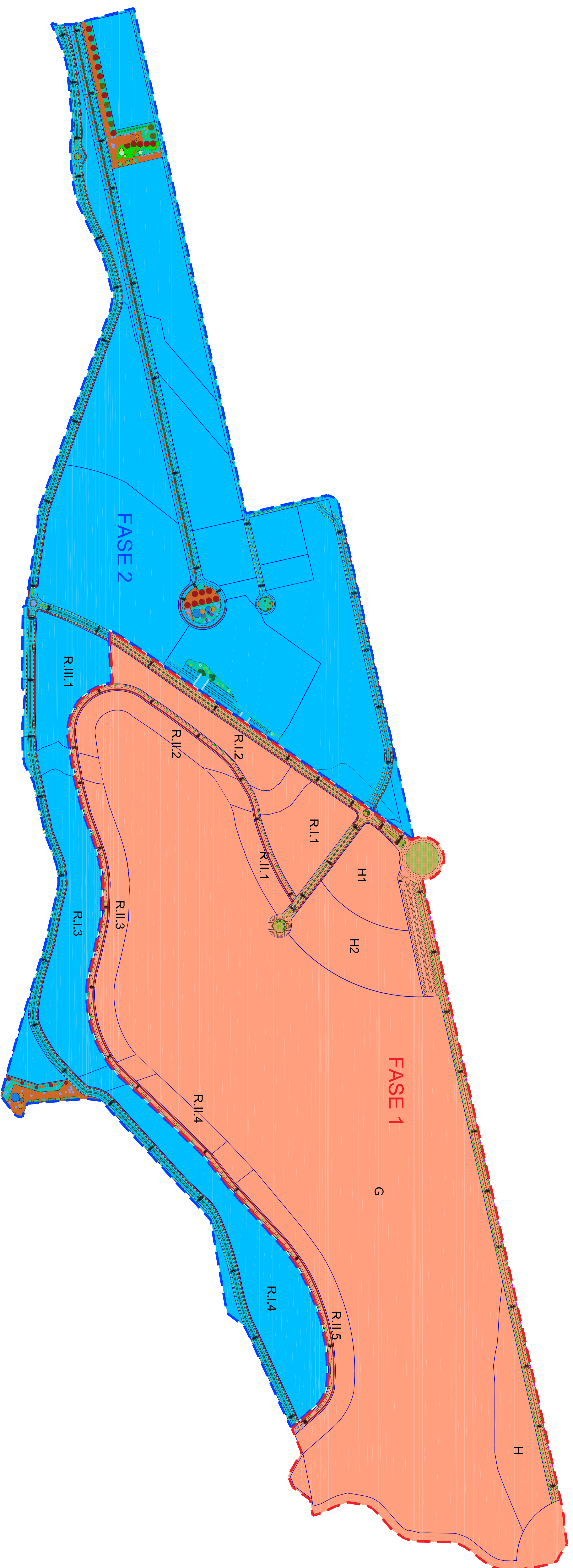

---	FASE 1
---	FASE 2

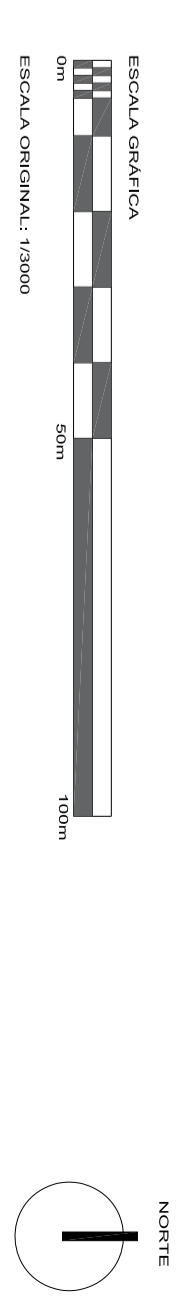

PROYECTO DE URBANIZACIÓN DEL
SECTOR "PEGO GOLF" EN PEGO (ALICANTE).

REPRESENTA	ESCALA	FECHA	Nº PLANO
FASES DE EJECUCION	1/3000	FEBRERO 2023	P 20

PROPIEDAD
CONSTRUCCIONES HISPANO GERMANAS S.A.